

The

A
R
T

of *Beauty*

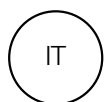
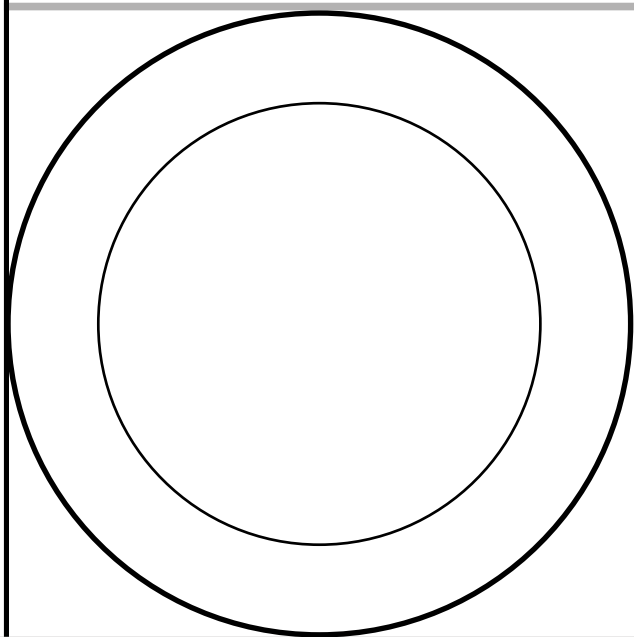

beauty®
progress



CATALOGO
Arredamento

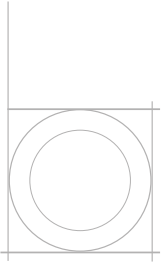
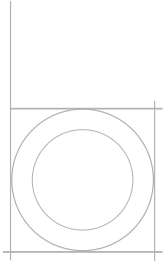
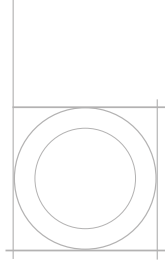
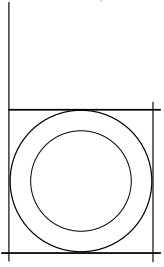
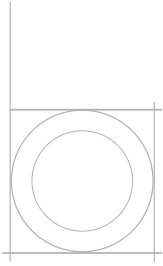
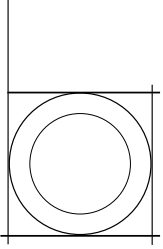

www.beautyprogress.net



Benvenuti da
Beauty Progress

Progettiamo SPAZI
REALIZZIAMO *Sogni*

I punti di vista cambiano,
IL CARATTERE RESTA.

Beauty Progress,
INNOVAZIONE GLOBALE CON UN
TOCCO DI ITALIAN STYLE.

Alta tecnologia, design, amore per i dettagli, qualità, efficienza: perchè limitarsi a una sola opportunità, se grazie a *Beauty Progress* è possibile ottenere tutte le qualità che desiderate?

Tecniche innovative e stile italiano si sposano in una visione d'insieme dove l'eccellenza si fa strada in ogni singolo dettaglio per dare vita a soluzioni uniche ed eleganti.

Progettare e realizzare prodotti dedicati alla bellezza che siano al tempo stesso ricchi di soluzioni tecnologiche d'avanguardia e di eleganti suggestioni visive.

Beauty Progress mette a disposizione un team professionale dedicato, in grado di supportare il Cliente in tutte le fasi operative di programmazione, realizzazione e gestione del Sistema Bellezza; **un modello di business innovativo per chiunque voglia progettare con serenità il proprio futuro**, dalla realizzazione della struttura, fino ai servizi, prodotti e macchinari da predisporre per lo svolgimento delle attività professionali.

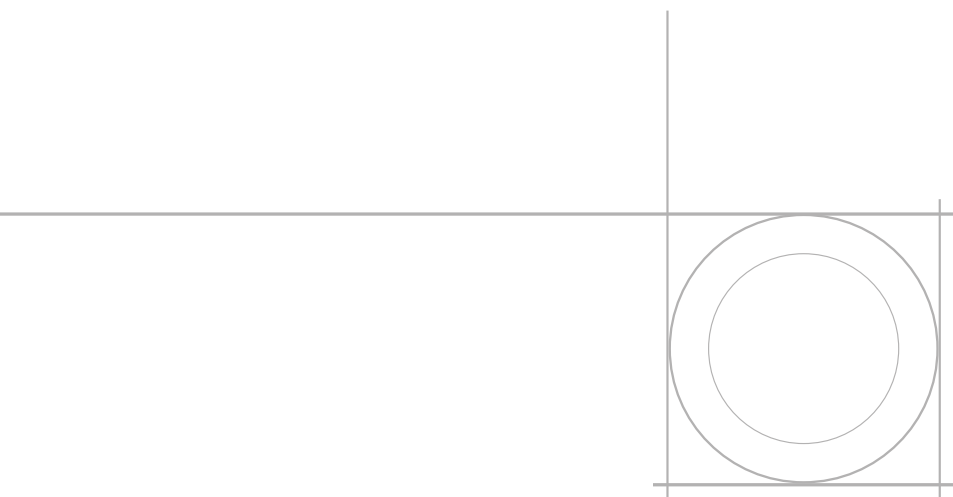

Libertà, funzionalità,
estetica e tecnologia:
progetta senza limiti,
dai forma ai tuoi sogni.

01

| *Reception*

02

| *Mobili*

03

| *Make Up*

04

| *Lettini*

05

| *Poltrone*

06

| *Manicure*

07

| *Carrelli*

08

| *Mensole*

09

| *Sgabelli*

10

| *Attesa*

11

| *Accessori*

01

G f @ p y v
www.beautyprogress.net

RECEPTION

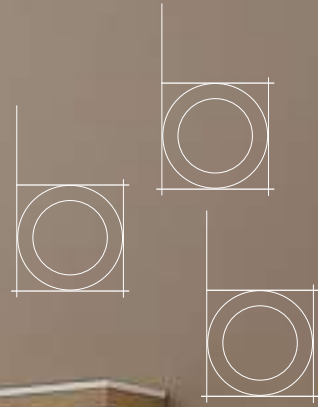

TORNA ALL'INDICE

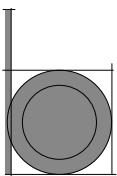

Cube Reception

FINITURE

Struttura bianco lucido



Rovere bardolino



Larice bianco



Wengé naturale



- **ARCO-RCB** - small 92x100



- **ARCO-RCBB** - bis 92x150



- **ARCO-RCTB** - tris 92x200

Cube Reception

Cube è una reception realizzata in nobilitato bianco lucido con dettagli frontali disponibili in larice bianco, wengé naturale e rovere bardolino. La reception può essere composta dal solo modulo centrale oppure è possibile aggiungere una o due vetrine espositive.

I moduli con vetrinetta espositiva possono essere posizionati sulla destra e sulla sinistra per attirare lo sguardo delle clienti più attente. Il modulo fisso centrale è dotato di piano estraibile porta-planning, foro passacavi, cassetto con chiusura, vano giorno e anta con ripiano.

DIMENSIONI (mm)

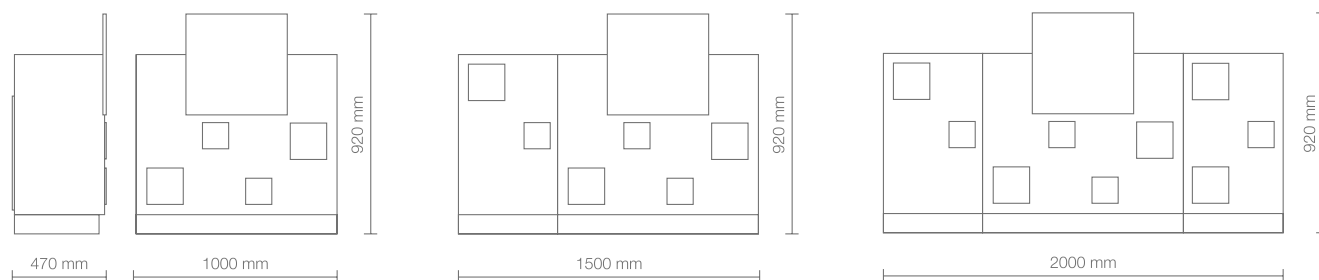

FINITURE

Struttura bianco lucido



Light Desk Reception

Light Desk è una reception minimale che si caratterizza per la sua eleganza. È realizzata in nobilitato bianco lucido. La reception può essere composta dal solo modulo centrale (Light Desk) oppure si possono aggiungere una o due vetrine espositive Light (destra e/o sinistra). Il modulo fisso centrale è riservato e funzionale: è dotato di piano estraibile porta-planning, foro passacavi, cassetto con chiusura, vano giorno e anta con ripiano. Il pannello frontale retro-illuminato oltre a garantire riservatezza permette di avere un piano d'appoggio.



• **ARCO-RLDB** - small 92x100



• **ARCO-RLDBB** - bis 92x151



• **ARCO-VLB** - vetrina 92x51



• **ARCO-RLDTB** - tris 92x202

DIMENSIONI (mm)

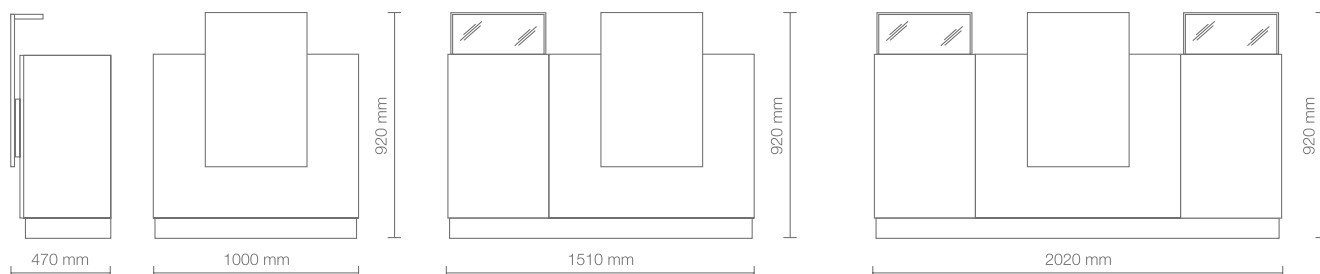
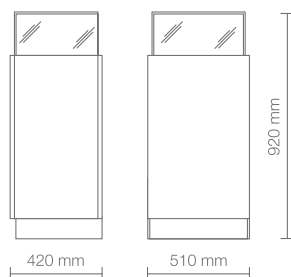



Reception Light Desk
Vetrinetta Light
Mensola Stratos



Reception Nat 16/9



Reception Nat

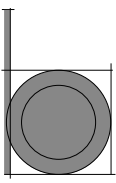

FINITURE

Struttura Rovere naturale



• ARCO-RNRN



Nat Reception

Reception Nat, dallo stile elegante e minimale è realizzata in rovere naturale. Dotata di cassetto con chiave, vani a vista, passacavo e piano di appoggio superiore.

DIMENSIONI (mm)

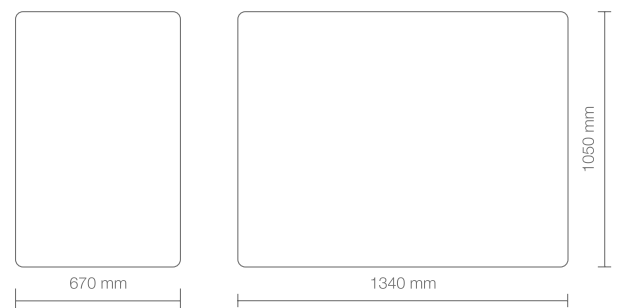

FINITURE

Struttura Rovere naturale



Nat 16/9 Reception

Reception Nat 16/9 dallo stile elegante e minimale è realizzata in rovere naturale. Dotata di cassetto con chiave, vani a vista, anta push con ripiano e divisorio marrone tiger per area riservata.

DIMENSIONI (mm)



• ARCO-RN16/9RN





Reception Millennium Skai
Attesa B-Side



Reception Millennium Wood
Sgabello Divine Reception

FINITURE

Struttura Nobilitato bianco



skai colors

Millennium Reception

Millennium è disponibile in due bellissime versioni. Per uno stile minimale e moderno, scegli la versione con frontale in plexiglass bianco retro illuminato. Per un design più sofisticato ed elegante opta invece per la versione con frontale personalizzabile da una vasta gamma di colori skai. La struttura della cassa è molto funzionale, dotata di vani porta oggetti e un comodo cassetto.

DIMENSIONI (mm)

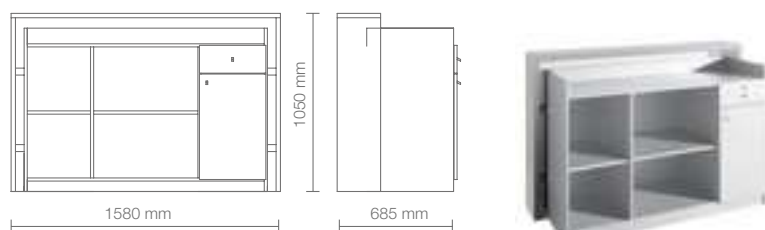

- ARMB-RD/135 - plexiglass
- ARMB-RD/037 - skai



FINITURE

Struttura Nobilitato bianco



Vintage 01



Black Ash 02



Cement Grey 03



Moka 04



Oak 05



White Ash 06



- ARMB-RD/038



Millennium Wood Reception

Postazione reception dalla struttura in colore bianco frassinato dotata di più vani a giorno, di uno sportello/armadietto e cassetto con chiusura a chiave. Il frontale in nobilitato è disponibile in diversi colori ed essenze lignee. Ampia, pratica e semplicemente funzionale!

DIMENSIONI (mm)

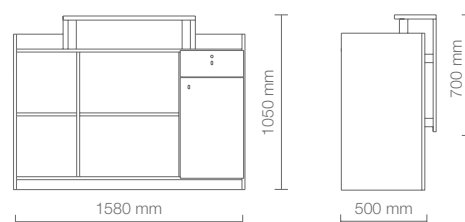

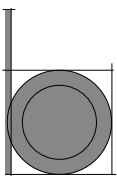

FINITURE

Struttura Nobilitato bianco



skai colors

Form Reception

Form si distingue per la sua forma curva; il design dona un'immagine morbida e allo stesso tempo i materiali restituiscono una sensazione di forte solidità e compattezza. Una cassa che non passa certo inosservata grazie anche alla totale personalizzazione tramite i vari Skai® Colours del pannello frontale che rendono Form adattissima ad ogni tipo di salone. Disponibile in quattro versioni: Singola, singola con mobiletto, singola con vetrina e singola con mobiletto e vetrina.



• ARMB-RD/250



• ARMB-RD/252



• ARMB-RD/254



• ARMB-RD/256

DIMENSIONI (mm)

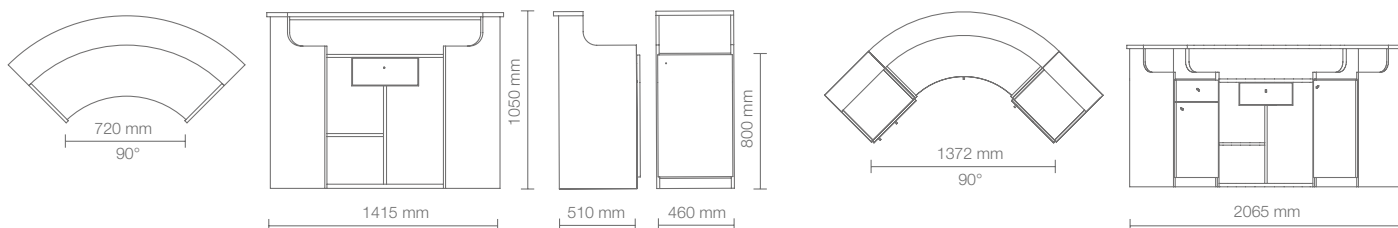



Reception Form
Attesa Hex



Reception Smart
Attesa Lounge Bis

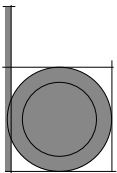

FINITURE

Struttura Nobilitato bianco



skai colors

Smart Reception

Questa elegante reception in nobilitato bianco cattura l'attenzione grazie al pannello anteriore rivestito in Skai® e la sua curva che forma un angolo di 90°. L'illuminazione a LED accentua la forma del pannello ricoperto di Skai®, mentre aggiunge importanza alla reception. La cassa Smart è disponibile con vetrine laterali e armadi laterali.



• ARMB-RD/260



• ARMB-RD/262



• ARMB-RD/264



• ARMB-RD/266

DIMENSIONI (mm)

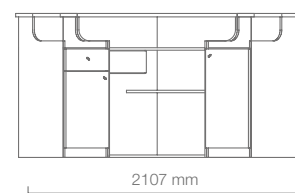
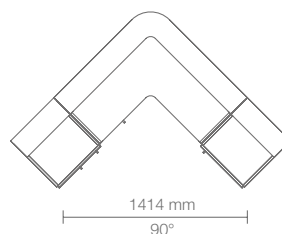
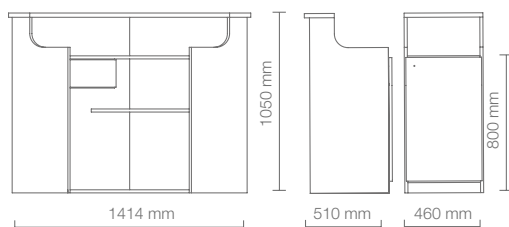
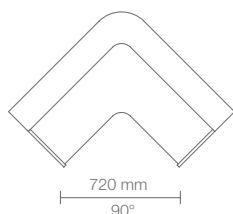

02



G f @ p y v

www.beautyprogress.net

MOBILI

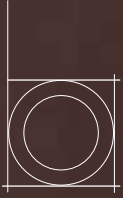

TORNA ALL'INDICE

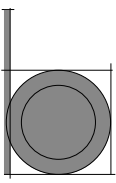

FINITURE

Struttura bianco opaco



Bianco opaco



Miele



Rovere Fumè



Paper



Creo 900 Mobile servizio

Il mobile Creo, realizzato in legno Nobilitato bianco opaco, ha linee semplici ma moderne e arreda, con originalità e stile, ogni ambiente. È dotato di due ante con ripiani, chiusura ammortizzata, top in laminato ed apertura push/pull e piedini in acciaio.

Creo 1350 Mobile servizio

Il mobile Creo, realizzato in legno Nobilitato bianco opaco, ha linee semplici ma moderne e arreda, con originalità e stile, ogni ambiente. È dotato di due ante con ripiani, tre cassetti con guida a scomparsa con self-closing, chiusura ammortizzata, top in laminato ed apertura push/pull e piedini in acciaio.



- **ARCO-MC900B** - bianco 900
- **ARCO-MC1350B** - bianco 1350

- **ARCO-MC900M** - miele 900
- **ARCO-MC1350M** - miele 1350

- **ARCO-MC900RF** - fumè 900
- **ARCO-MC1350RF** - fumè 1350

- **ARCO-MC900P** - paper 900
- **ARCO-MC1350P** - paper 1350

DIMENSIONI (mm)

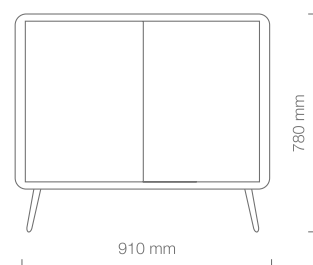
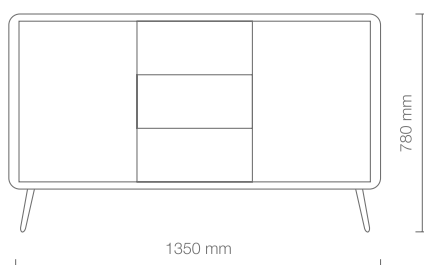
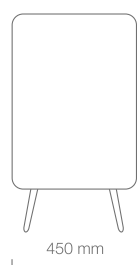

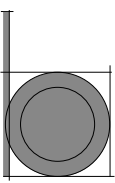

FINITURE

Struttura bianco opaco



Bianco opaco



Miele



Rovere Fumè



Paper



Creo 900 H2o Mobile servizio

Il mobile Creo H2O, realizzato in legno Nobilitato bianco opaco, ha linee semplici ma moderne e arreda, con originalità e stile, ogni ambiente. È dotato di due ante con ripiani, chiusura ammortizzata, top in laminato, apertura push/pull, piedini in acciaio e un lavabo. Il mobile Creo è disponibile in diverse finiture: bianco opaco, olmo miele, rovere fumè e paper.

OPTIONAL: miscelatore

Creo 135 H2o Mobile servizio

Il mobile Creo, realizzato in legno Nobilitato bianco opaco, ha linee semplici ma moderne e arreda, con originalità e stile, ogni ambiente. È dotato di due ante con ripiani, tre cassetti con guida a scomparsa con self-closing, chiusura ammortizzata, top in laminato, apertura push/pull, piedini in acciaio e un lavabo.

OPTIONAL: miscelatore



- ARCO-MCH20900B - bianco 900
- ARCO-MCH201350B - bianco 1350

- ARCO-MCH20900M - miele 900
- ARCO-MCH201350M - miele 1350

- ARCO-MCH20900RF - fumè 900
- ARCO-MCH201350RF - fumè 1350

- ARCO-MCH20900P - paper 900
- ARCO-MCH201350P - paper 1350

DIMENSIONI (mm)

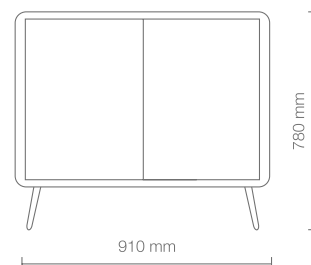
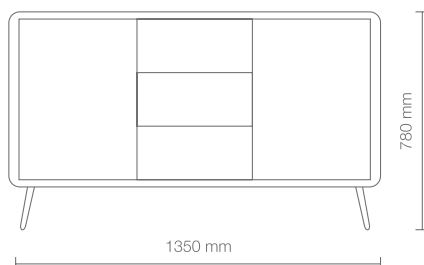
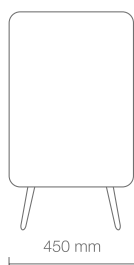

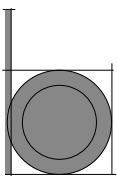

Swing Mobile & H2O

FINITURE

Struttura bianco lucido



Rovere bardolino



Larice bianco



Wengé naturale



• ARCO-MSWRB

Swing Mobile servizio

Swing ha linee semplici e moderne, che si adattano ad ogni stile. Il mobile è realizzato in Nobilitato bianco lucido con frontali in legno ed è dotato di quattro cassetti con apertura push/pull. Il cliente può scegliere al momento del montaggio se posizionare il mobile in versione allineata oppure con la parte superiore decentrata rispetto a quella inferiore.



• ARCO-MSWW



• ARCO-MSWLB

Swing H2O Mobile servizio

Swing H2O ha linee semplici e moderne, che si adattano ad ogni stile. Il mobile è realizzato in Nobilitato bianco lucido con frontali in legno ed è dotato di quattro cassetti con apertura push/pull e un lavabo.

OPTIONAL: miscelatore



• ARCO-MSH20W



• ARCO-MSH20LB



• ARCO-MSH20RB

DIMENSIONI (mm)

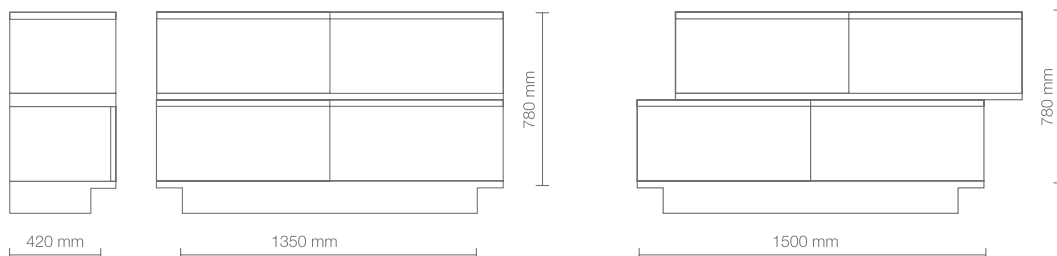



Mobile Creo H20



Mobile Swing H20

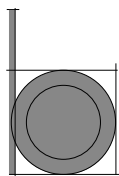

FINITURE

Rovere bardolino



Larice bianco

*Et-no* Mobile servizio

Et-No è un mobile realizzato in legno nobilitato dallo stile moderno che perme di arredare con originalità ogni ambiente.

È possibile personalizzare il mobile a piacimento con ante, cassetti o con vani a giorno. Lo zoccolino in legno può essere sostituito da 4 piedini cromati.

Et-no 45

È dotato di un'anta con chiusura ammortizzata, maniglia cromata e zoccolino laterale o piedino cromato.

- ARCO-ET45RB - rovere
- ARCO-ET45LB - larice

*Et-no 135*

È dotato di due ante con chiusura ammortizzata, tre cassetti con guida a scomparsa con self-closing, zoccolino laterale o piedino cromato.

- ARCO-ET135RB - rovere
- ARCO-ET135LB - larice

Et-no 90

È dotato di due ante con chiusura ammortizzata, maniglie cromate e zoccolino laterale o piedino cromato.

- ARCO-ET90RB - rovere
- ARCO-ET90LB - larice

DIMENSIONI (mm)

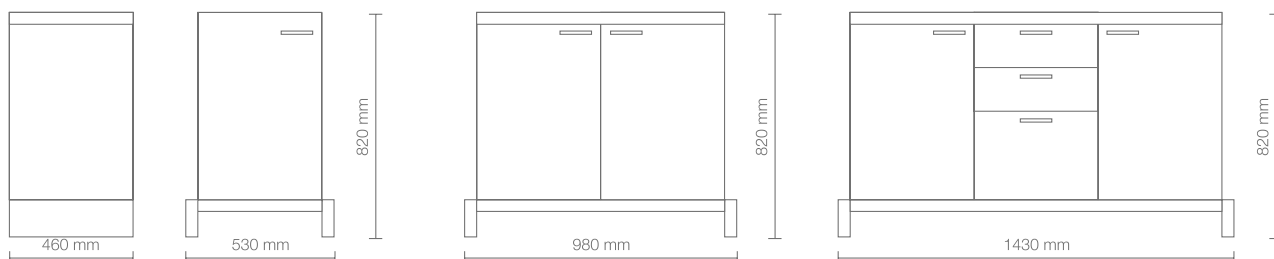

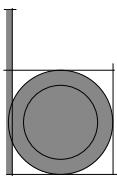

FINITURE

Rovere bardolino



Larice bianco



Et-no H20 Mobile servizio

Et-No H20 è un mobile realizzato in legno nobilitato dallo stile moderno che perme di arredare con originalità ogni ambiente. È possibile personalizzare il mobile a piacimento con ante, cassetti o con vani a giorno. Lo zoccolino in legno può essere sostituito da 4 piedini cromati. Dotato di lavabo.

OPTIONAL: miscelatore

Et-no 45

È dotato di un'anta con chiusura ammortizzata, maniglia cromata e zoccolino laterale o piedino cromato e un lavabo.

• ARCO-ETH2045RB - rovere

• ARCO-ETH2045LB - larice



Et-no 135

È dotato di due ante con chiusura ammortizzata, tre cassetti con guida a scomparsa con self-closing, zoccolino laterale o piedino cromato e un lavabo.

• ARCO-ETH20135RB - rovere

• ARCO-ETH20135LB - larice

Et-no 90

È dotato di due ante con chiusura ammortizzata, maniglie cromate e zoccolino laterale o piedino cromato e un lavabo.

• ARCO-ETH2090RB - rovere

• ARCO-ETH2090LB - larice

DIMENSIONI (mm)

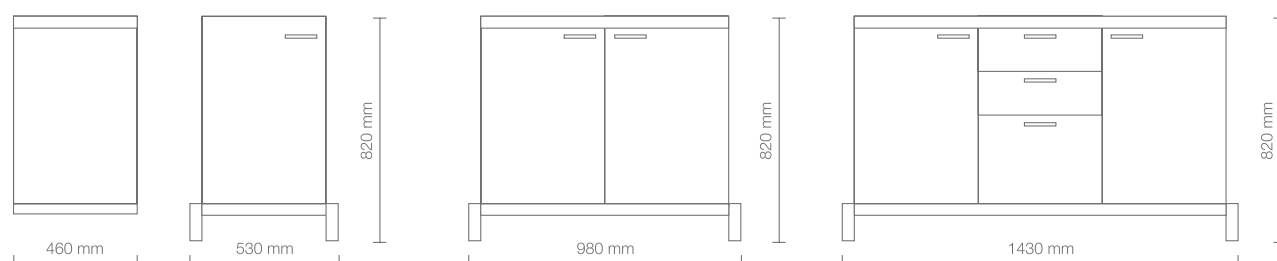



Mobile Et-No H20



Mobile Mix H20

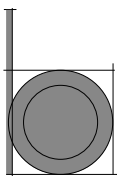

FINITURE

Struttura Legno Frassino bianco



Rovere bardolino



Mix H2o Mobile servizio

Il mobile componibile by *Beauty Progress* è realizzato in legno Frassino bianco. Lo stile moderno permette di arredare con originalità ogni ambiente ottimizzando gli spazi che hai a disposizione. Disponibile nella finitura ROVERE BARDOLINO.

OPTIONAL: miscelatore

Mix 45 H2o

È dotato di un'anta con ripiano con chiusura ammortizzata, un lavabo e top.

- ARRBP-MIX45H2O - 80x45



Mix 135 H2o

Dotato di un'anta con ripiano e chiusura ammortizzata, un lavabo, top, un vano a giorno con finitura effetto legno e un'anta con chiusura ad anta push and pull.

- ARRBP-MIX135H2O - 72/80x135

Mix 90 H2o

Dotato di un'anta con ripiano e chiusura ammortizzata, un lavabo, un vano a giorno con finitura effetto legno e un'anta con chiusura ad anta push and pull.

- ARRBP-MIX90H2O - 72/80x90

DIMENSIONI (mm)

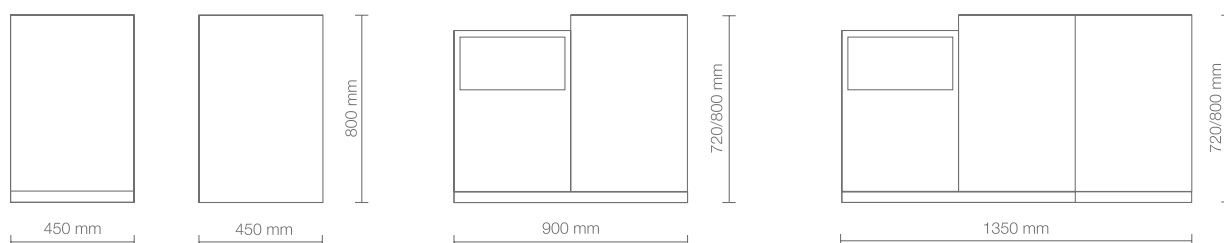



Mobile Mumbai



Mobile Horizon

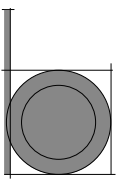

• ARRNI-N9155



• ARRNI-N9151

• ARRNI-N9153

• ARRNI-N9152

FINITURE

Struttura bianco opaco



Rovere chiaro



Mumbai H2O Mobile servizio

Mumbai H2O è il mobile di servizio modulare con struttura nera o bianca opaca composta da:

1. modulo con top in vetro pure white con lavandino in ceramica bianca e miscelatore cromato, suddiviso con ante battenti.

1A) anta sotto al lavabo è usata per ispezionare gli impianti idraulici;

1B) anta con recycle per rifiuti e salviette utilizzate;

1C) vano a giorno per l'Hot Caby (scaldasalviette) + sotto anta apribile con ripiano all'interno.

2. modulo con 3 cassetti per gli utensili sterilizzati.

3. modulo con carrello a scomparsa e ruote piroettanti per cerette con cassetti all'interno.

4. barre pensili con aggancio a parete.



DIMENSIONI (mm)

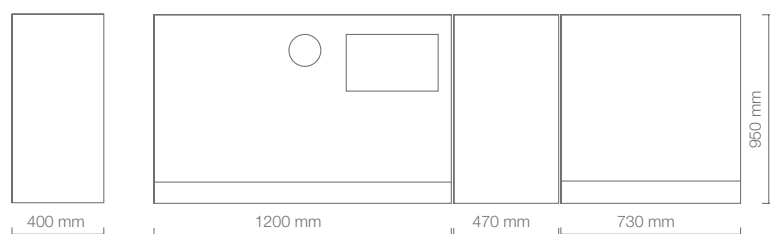

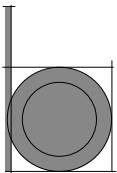

• ARRNI-N9165 - lavabo

• ARRNI-N9166 - cabinet

FINITURE

Struttura Cashmire



Nero



Horizon Mobile servizio

Horizon è il mobile di servizio disponibile con lavabo inox e miscelatore cromato (H2O) o senza lavabo (cabinet):

Base e mobile con ante in melaminico finitura sabbia opaco (cashmire), contenitore sotto mobile in plex fumè, staffe metalliche di sostegno in finitura nero opaco e top superiore in vetro nero.

DIMENSIONI (mm)

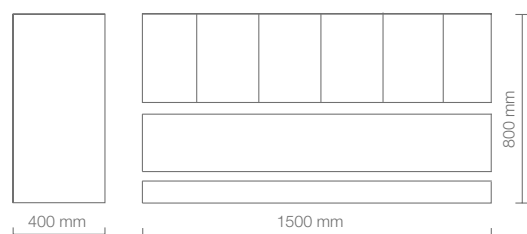

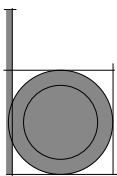

- ARRNI-N93001

FINITURE

Struttura Rovere chiaro



Rovere sbiancato



Noce



Kiwi H2O Mobile servizio

Kiwi è il mobile con lavabo rettangolare in acciaio inox e miscelatore cromato. Piano in vetro temprato serigrafato bianco e struttura rivestita in legno con angoli arrotondati. Dotato di numerosi scomparti e cassetti a spinta.



DIMENSIONI (mm)

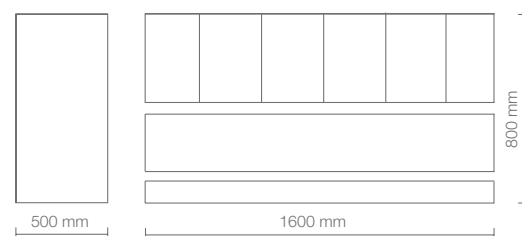

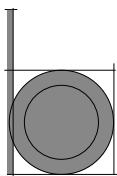

FINITURE

Struttura Rovere naturale



- ARCO-MN650ARN

Nat 650 Air Mobile servizio Pensile

Mobiletto NAT 650 a parete con anta a ribalta in nobilitato con finitura rovere naturale. Nat 650 può creare una composizione con altri mobiletti sospesi.

Nat 1350 Air Mobile servizio Pensile

Mobiletto NAT 1350 a parete con anta a ribalta in nobilitato con finitura rovere naturale. Nat 1350 può creare una composizione con altri mobiletti sospesi.



- ARCO-MN1350ARN



- ARCO-MN1350ERN

Nat 1350 Earth Mobile servizio

Mobiletto NAT 1350 a parete con anta a ribalta in nobilitato con finitura rovere naturale e piedini marrone tiger.

DIMENSIONI (mm)

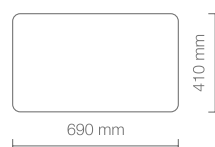
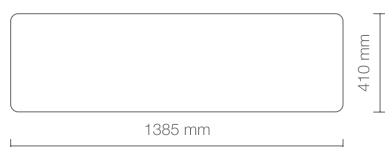

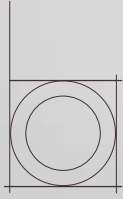
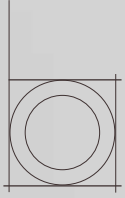

Mobile Nat 650
& Nat 1350 Earth

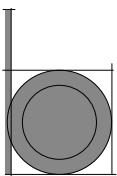

Nat H2O Mobile



FINITURE

Struttura Bianco opaco



Nat H2O Mobile servizio Pensile

Mobiletto NAT H2O a parete in laminato HPL bianco opaco. Foro frontale per appoggio asciugamani. Completo di lavabo.

OPTIONAL: miscelatore

DIMENSIONI (mm)

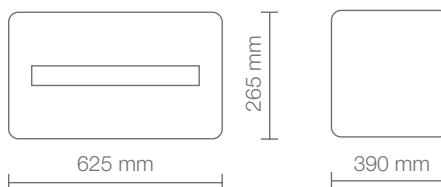

- ARCO-MNH20650B



03

G f @ p y v

www.beautyprogress.net

MAKE UP



TORNA ALL'INDICE



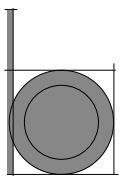

New Make-up & Celebrity

FINITURE

Struttura Nobilitato bianco



Rovere bardolino



Larice bianco



- ARCO-SNMUPB

New Make-Up Beauty Corner

New Make Up, dalla struttura in legno Nobilitato bianco lucido, è composto da un mobiletto dotato di due cassetti laterali push-pull che si possono aprire totalmente e il divisorio interno permette di disporre in modo ordinato i prodotti. Per completare, una specchiera dal design minimale con telaio in alluminio verniciato bianco e illuminazione a led ad alta potenza.

OPTIONAL: gambe cromate

DIMENSIONI (mm)



- ARCO-MNMUPRB - rovere

- ARCO-MNMUPLB - larice

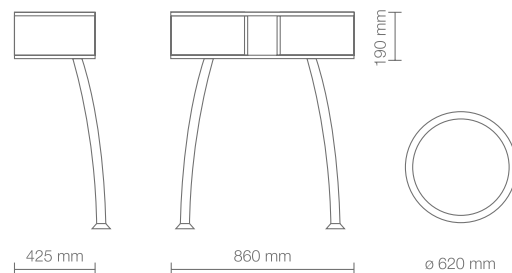

FINITURE

Struttura Nobilitato bianco



Celebrity Beauty Corner

Lo specchio, dalla forma quadrata e minimale, cattura l'attenzione con le sue grandi dimensioni. Con 10 lampadine posizionate ai lati e al di sopra dello specchio, l'area di lavoro professionale è ben illuminata. Al di sotto dello specchio una struttura di colore bianco, elegante ma estremamente funzionale, dotata di due cassetti, completa lo stile stupefacente.

DIMENSIONI (mm)

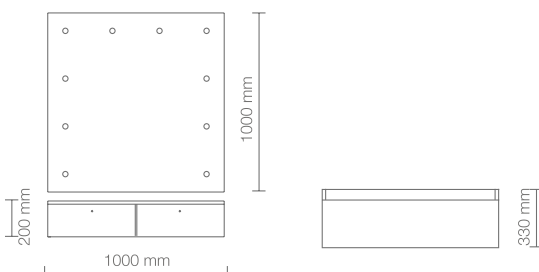

- ARMB-MB/PL61



Corner Celebrity
Poltrona Eva



Corner Las Vegas
Poltrona Natalie



Corner New Make Up
Poltrona New Make Up



Corner Elegance
Poltrona Natalie

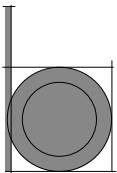

• ARMB-MB/PL52



FINITURE

Struttura Nobilitato bianco



Las Vegas Beauty Corner

Lo specchio, dalla forma rettangolare, è posizionabile sia in verticale che in orizzontale ed ha 8 lampadine posizionate ai lati e al di sopra dello specchio per un'area di lavoro professionale e ben illuminata. La struttura, elegante ed estremamente funzionale in Nobilitato bianco, è dotata di due cassetti.

DIMENSIONI (mm)

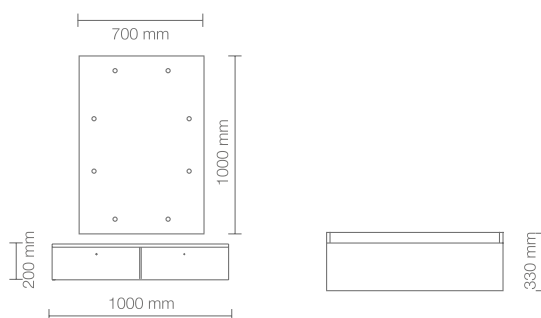

FINITURE

Struttura Nobilitato bianco



Elegance Beauty Corner

L'esclusivo corner Elegance conferisce alla postazione di lavoro uno stile barocco. Gli eleganti piedi in metallo verniciato, sormontati da una struttura in nobilitato di colore bianco, conferiscono alla specchiera uno stile minimale. Lo specchio di forma rettangolare è contornato da 8 lampadine LED, per una perfetta illuminazione. Poggiapiedi in acciaio inox.

DIMENSIONI (mm)

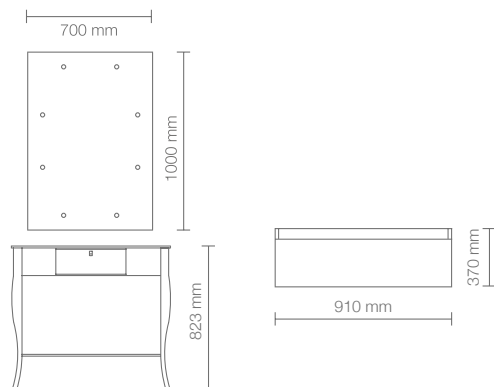

• ARMB-MB/PL80

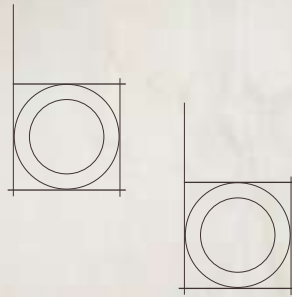



LETTINI FISSI

Beauty Spa & Fisioterapia



www.beautyprogress.net

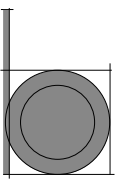

• ARCO-LFRN

FINITURE

Struttura Rovere naturale



0° to 45°

Flow Lettino Trattamenti

Lettino da massaggi in nobilitato finitura rovere naturale. Materasso in skai bianco dotato di foro facciale e porta rotolo. Testata regolabile manualmente.

OPTIONAL: materasso riscaldato

DIMENSIONI (mm)

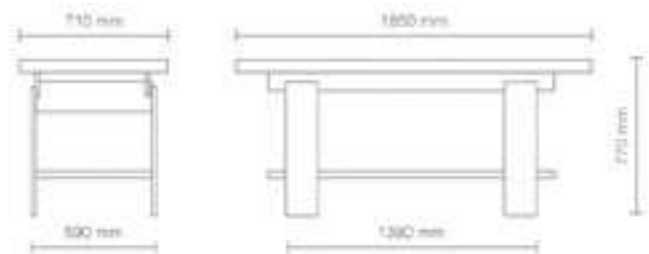

FINITURE

Struttura bianco lucido



0° to 45°

Rovere bardolino



Larice bianco



Living Lettino Trattamenti

Living è un lettino per massaggi elegante dalla struttura bianco opaco con piano d'appoggio disponibile in due diverse finiture: larice bianco e rovere bardolino. Il materasso in skai bianco è dotato di foro facciale, relativo tappo e portarotolo. La testata è regolabile manualmente.

OPTIONAL: materasso riscaldato

DIMENSIONI (mm)

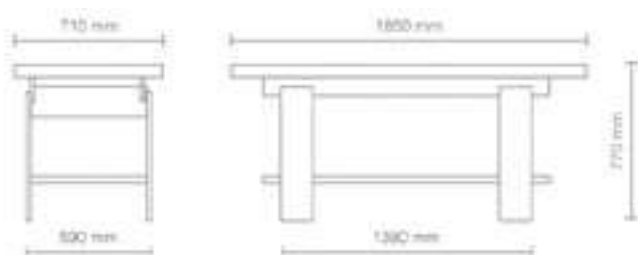

• ARCO-LLRB - rovere



• ARCO-LLLB - larice



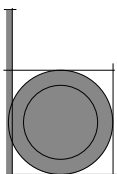

FINITURE

Struttura bianco lucido



0° to 45°

Rovere bardolino



Larice bianco



Wengé naturale



- ARCO-BPLSWRB - rovere
- ARCO-BPLSWW - wengé
- ARCO-BPLSWLB - larice

Swing Lettino Trattamenti

Lettino per massaggi realizzato in Nobilitato bianco lucido dotato di due cassetti, piano estraibile per macchinari, due vani espositivi per prodotti, vano di ampie dimensioni dove poter posizionare attrezzature estetiche, rotoli, termo coperta ecc. Materasso a profilo sagomato, foro facciale e relativo tappo rivestito in skai bianco. Schienale regolabile manualmente e porta rotolo.

DIMENSIONI (mm)

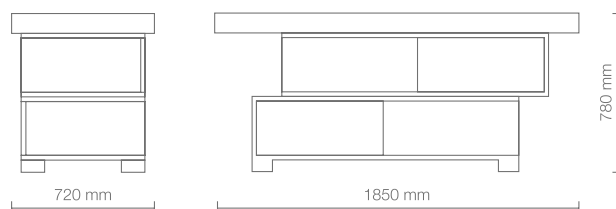

FINITURE

Struttura bianco lucido



0° to 45°

Rovere bardolino



Larice bianco



Bianco opaco



Creo Lettino Trattamenti

Lettino per massaggi con una struttura dalle linee curve ed aggraziate. Il materasso, realizzato in skai bianco, è dotato di angoli arrotondati e di foro facciale con relativo tappo di chiusura. La testata è regolabile manualmente in diverse posizioni per poter lavorare al meglio. È dotato di piano d'appoggio disponibile in tre diverse finiture.

OPTIONAL: materasso riscaldato

DIMENSIONI (mm)

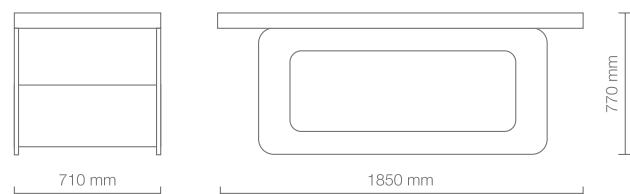

- ARCO-BPLCRB - rovere



- ARCO-BPLCLB - larice
- ARCO-BPLCBO - bianco opaco

**Lettino, Carrello, Mobile Swing
Mensola Slim**

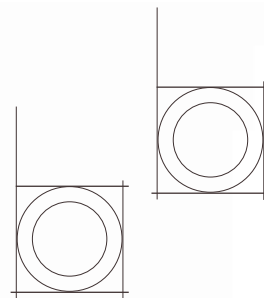

**Lettino e Carrello Creo
Sgabello Flex
Specchiera Bubbles**

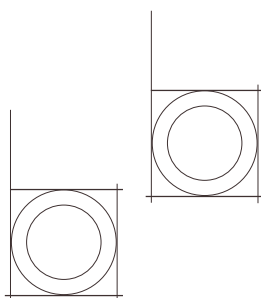

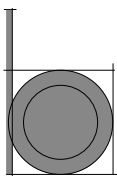

FINITURE

Acero sbiancato



Wengé



0° to 45°

Antias Lettino Trattamenti

Lettino per massaggi realizzato in multistrato di betulla con finitura acero sbiancato o wengé. Materasso a profilo sagomato, foro facciale e relativo tappo rivestito in skai bianco. Schienale regolabile manualmente, porta rotolo e ripiano porta strumenti.

DIMENSIONI (mm)

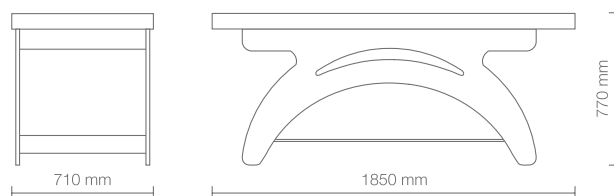

• **ARCO-BPLAAS** - acero

• **ARCO-BPLAW** - wengé

Lettino Antias
Carrello Hosi
Mensola Elos



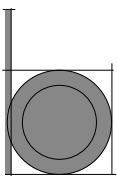

FINITURE

Struttura Legno naturale



0° to 40°



• ARWE-WK-S017

Regolar Lettino Trattamenti

Lettino fisso a 2 sezioni dal design minimalista, in legno naturale di alta qualità. Sistema innovativo di regolazione dell'altezza e inclinazione dello schienale in tre posizioni preimpostate. Imbottitura ad alto comfort con rivestimento in PU bianco di alta qualità e facile da pulire.

DIMENSIONI (mm)

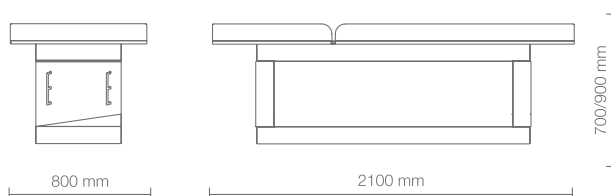

FINITURE

Struttura Wengé



0° to 60°

Tino Lettino Trattamenti

Lettino di legno fisso di colore wengé a 1 snodo. Ripiano inferiore per deposito di materiale. Schienale regolabile in diverse posizioni prestabilite. Rivestimento in PVC color crema di facile pulizia. Portarotolo compreso.

DIMENSIONI (mm)

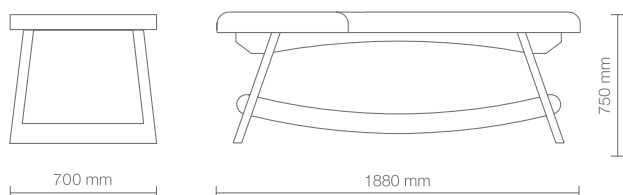

• ARWE-WK-S002

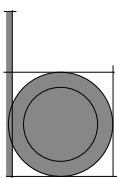

• **ARWE-2203H**

FINITURE

Struttura Cromata



0° to 45°

Orione Lettino Trattamenti

Lettino a 1 snodo dalla struttura cromata. Inclinazione dello schienale regolabile manualmente. Cuscino poggiatesta estraibile con foro facciale. Rivestimento in PU bianco di grande qualità e facile pulizia.

DIMENSIONI (mm)

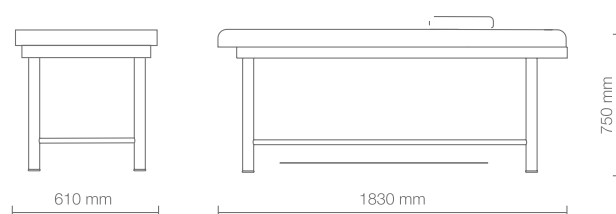

FINITURE

Struttura bianco lucido



0° to 45°

Fenice Lettino Trattamenti

Lettino fisso multifunzionale a 1 snodo dalla struttura robusta. Inclinazione dello schienale regolabile manualmente e foro facciale. Rivestimento in PVC bianco di facile pulizia. Dotato di portarotolo.

DIMENSIONI (mm)

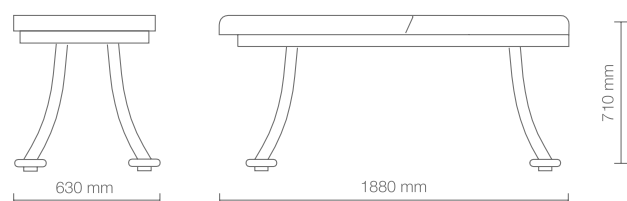

• **ARWE-WK-F002**



LETTINI ELETTRICI

Beauty Spa & Fisioterapia



www.beautyprogress.net

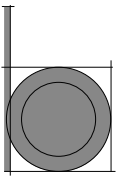

Nat Evo & Nat Evo Plus



- ARCO-LNERN

FINITURE

Struttura Rovere naturale



MOTORI

2



Up & Down 0° to 45°

Nat Evo Lettino Elettrico

Lettino elettrico mono colonna dotato di 2 motori per la regolazione dell'altezza e dell'inclinazione dello schienale tramite telecomando. Materasso in skai, basamento con anta a ribalta con finitura rovere naturale.

OPTIONAL: materasso riscaldato e braccioli

DIMENSIONI (mm)

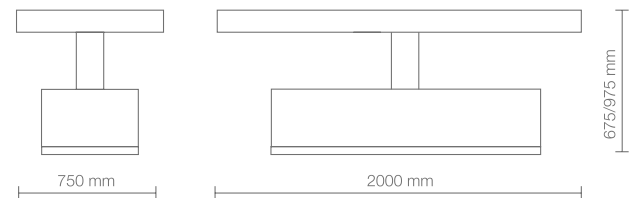

FINITURE

Struttura Rovere naturale



MOTORI

4



Up & Down Mover

Nat Evo Plus Lettino Elettrico

Lettino elettrico con doppia colonna dotato di 4 motori per la regolazione dell'altezza e dell'inclinazione del materasso tramite telecomando. Materasso in skai, basamento con anta a ribalta con finitura rovere naturale.

OPTIONAL: materasso riscaldato e braccioli

DIMENSIONI (mm)

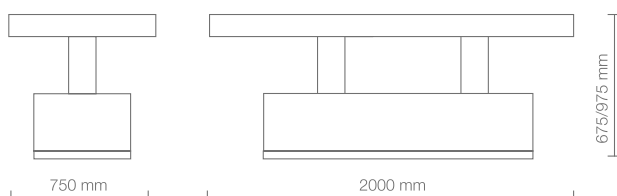

- ARCO-LNEPRN





Lettino, Carrello, e Mobili
Nat



Lettino, Carrello, e Mobili
Nat

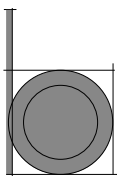

FINITURE

Struttura bianco opaco



MOTORI

4

skai colors



Up & Down Mover



- ARCO-LVB

Vision Lettino Elettrico

Lettino elettrico con doppia colonna. Materasso in skai. Dotato di 4 motori per la regolazione dell'altezza e dell'inclinazione del materasso tramite telecomando. Basamento bianco opaco e ovale disponibile in 12 colori skai.

OPTIONAL: materasso riscaldato e braccioli

DIMENSIONI (mm)

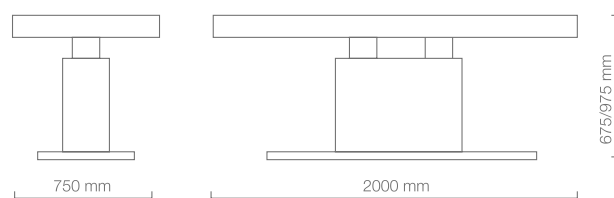

FINITURE

Struttura bianco opaco



MOTORI

2

skai colors



Up & Down 0° to 45°

Sense Lettino Elettrico

Lettino elettrico mono colonna dotato di 2 motori per la regolazione dell'altezza e dello schienale tramite telecomando. Materasso in skai, basamento bianco opaco e rivestimento dell'ovale disponibile in 12 colori skai.

OPTIONAL: materasso riscaldato e braccioli

DIMENSIONI (mm)

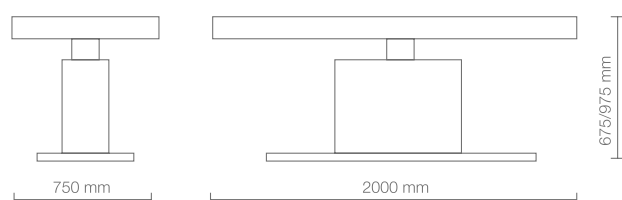

- ARCO-LSB



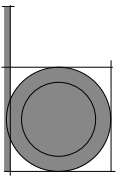

Lumina & E-motion 2.0



• ARCO-BPLLBO

FINITURE

Struttura bianco opaco



MOTORI

4



Up & Down Mover

Lumina Lettino Elettrico

Lumina è il lettino elettrico multifunzionale dotato di 4 motori e grazie alla funzione Trendelenburg offre innumerevoli opzioni di regolazione. Il movimento elettrico del materasso è gestito tramite telecomando ed è dotato di un basamento con illuminazione LED che può essere utilizzato come appoggio per il posizionamento di prodotti. Il materasso è in skai bianco, il basamento in finitura bianco opaco.

DIMENSIONI (mm)

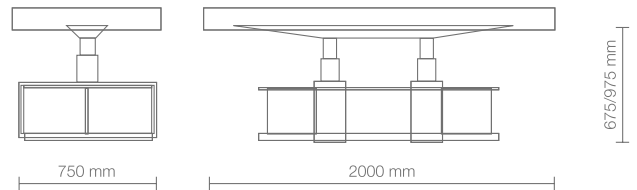

FINITURE

Struttura bianco opaco



MOTORI

1



Up & Down 0° to 45°

E-motion 2.0 Lettino Elettrico

E-motion è un lettino per massaggi con basamento in finitura bianco opaco con bordatura in micro lamina di acciaio spazzolato. Rivestimento materasso in skai bianco. Colonna regolabile in altezza elettricamente con comando a pedale. Materasso a profilo sagomato, foro facciale con relativo tappo e portarotolo. Schienale regolabile manualmente a 0°, 15°, 30°, 45°.

DIMENSIONI (mm)

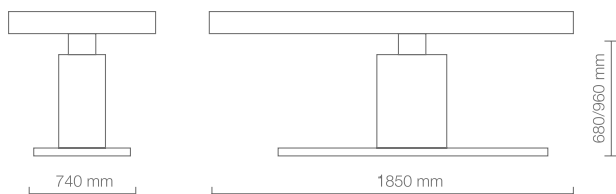

• ARCO-BPLEBL





Lettino Lumina
Sgabello Flex
Mensola Slim

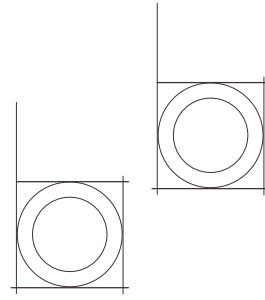

Lettino E-motion 2.0
Mobili e Mensole Nat
Carrello Creo

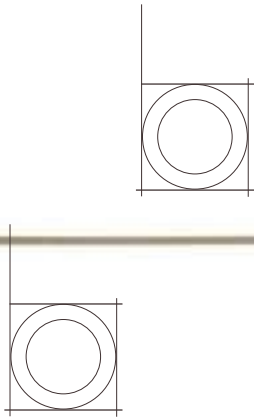

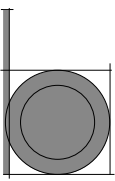

• **ARCO-LTCP** - paper

FINITURE

Struttura bianco opaco



Bianco opaco



Miele



Rovere Fumè



Paper



MOTORI

4



Up & Down Mover

The Clair Lettino Elettrico

The Clair è il lettino da massaggio elettrico dotato di 4 motori per la regolazione dell'altezza, dello schienale e delle gambe (regolazione dell'altezza e del materasso tramite telecomando). Materasso in skai bianco a profilo sagomato, foro facciale con relativo tappo.

OPTIONAL: materasso riscaldato e braccioli



• **ARCO-LTCB** - bianco



• **ARCO-LTCM** - miele



• **ARCO-LTCRF** - fumè



Up & Down 0° to 45°

The Ben Lettino Elettrico

The Ben è il lettino da massaggio monocolonna elettrico dotato di 4 motori per la regolazione dell'altezza, dello schienale e del gambale (regolazione dell'altezza e del materasso tramite telecomando). Materasso in skai bianco a profilo sagomato, foro facciale con relativo tappo.

OPTIONAL: materasso riscaldato e braccioli



• **ARCO-LTBP** - paper



• **ARCO-LTBB** - bianco



• **ARCO-LTBM** - miele



• **ARCO-LTBRF** - fumè

DIMENSIONI (mm)

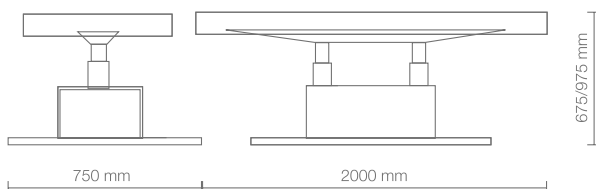

**Letino The Ben
Mobile Creo**

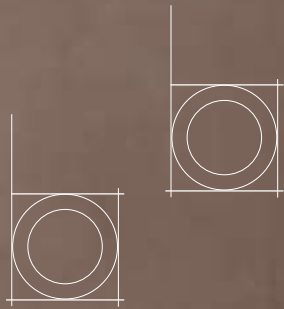

**Letino The Clair
Mobile e Carrello Creo**



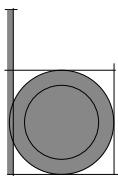

FINITURE

Struttura Wengé



MOTORI

3



Up & Down 0° to 60° 0° to 30°



- ARWE-2238TB



DIMENSIONI (mm)

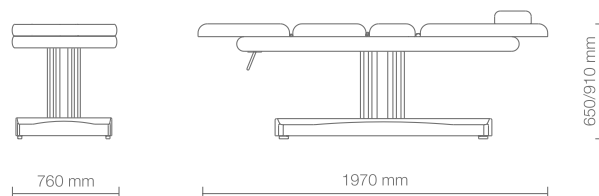

FINITURE

Struttura Wengé



MOTORI

2



Up & Down 0° to 65°

Itaca Lettino Elettrico

Lettino multifunzionale dalle alte prestazioni dotato di 2 motori che regolano l'altezza e l'inclinazione dello schienale. Struttura metallica color wengé. Rivestimento in PU bianco di grande qualità e facile da pulire. Portarotolo compresso.

DIMENSIONI (mm)

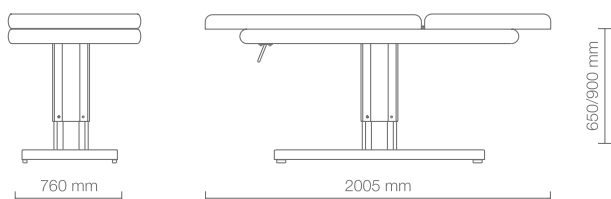

- ARWE-2238A



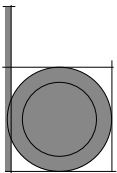

• ARWE-2249BB - wengè



• ARWE-2249 - bianco

FINITURE

Bianco



Wengé



MOTORI

4



Up & Down 0° to 65° 0° to 25°

Sidney Lettino Elettrico

Lettino a 4 motori che regolano l'altezza, l'inclinazione del lettino, lo schienale e il poggiatesta. Imbottitura dall'alto comfort con tappezzeria PU bianca di gran qualità. Materasso a un unico pezzo con 3 punti di articolazione. Lettino fornito di appoggiatesta regolabili e foro facciale. Disponibile anche con la base marrone.

DIMENSIONI (mm)

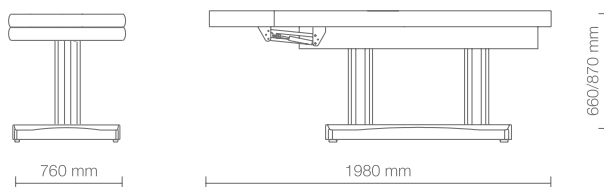

FINITURE

Bianco



Rovere chiaro



MOTORI

4

skai colors



Up & Down Mover

Abudhabi Lettino Elettrico

Lettino multifunzione 4 motori, per trattamenti viso, corpo e massaggi. Regolazione elettrica di altezza, schienale e gambe. Inclinazione schienale 72°. Materasso rivestito in skay, ignifugo e resistente agli olii. Base porta accessori.

OPTIONAL: opzione Thermic

DIMENSIONI (mm)

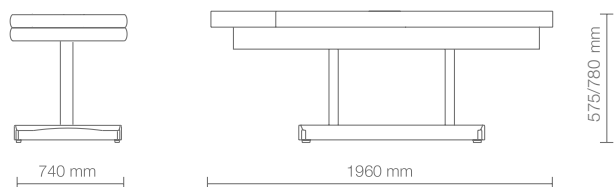

• ARRNI-N9447





Lettino Abudhabi
Mobile Mumbai
Sgabello Aloe



Lettino1 Dubai
Lettino2 Omnia
Mobile Kiwi
Carrello Vapo Mist
Sgabello Aloe

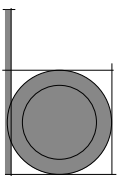

• ARRNI-N9035

FINITURE

Struttura bianco opaco



MOTORI

4



Up & Down Mover

Dubai Lettino Elettrico

Lettino multifunzione 4 motori, per trattamenti viso, corpo e massaggi. Regolazione elettrica di altezza, schienale e gambe. Materasso rivestito in PVC, ignifugo e resistente agli olii. Braccioli abbattibili con pompa-gas. Basamento nobilitato verniciato bianco.

OPTIONAL: opzione Thermic

DIMENSIONI (mm)

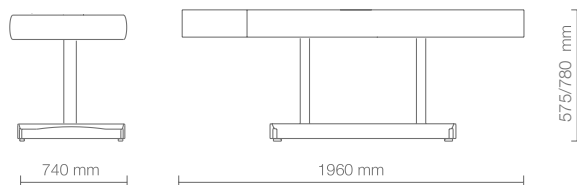

FINITURE

Rovere chiaro



Rovere sbiancato



MOTORI

3



Mover

Omnia Lettino Elettrico

Lettino multifunzione 3 motori, per trattamenti viso, corpo e massaggi. Regolazione elettrica di altezza, schienale e gambe. Materasso rivestito in PVC, ignifugo e resistente agli olii. Braccioli abbattibili con pompa-gas. Disponibile in Rovere chiaro o Rovere sbiancato.

OPTIONAL: opzione Thermic



• ARRNI-N90293

DIMENSIONI (mm)

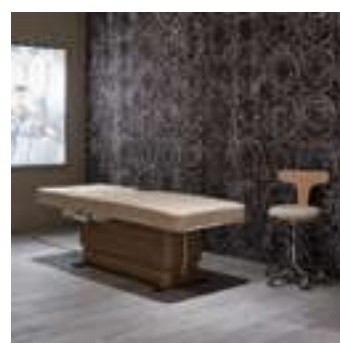
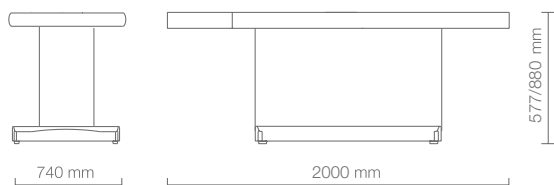

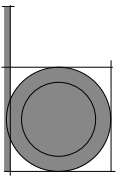

Sensus & Sensus Cabinet



- ARRNI-N9032

FINITURE

Struttura Grigio chiaro



MOTORI

4



Up & Down Mover

Sensus Lettino Elettrico

Lettino multifunzione 4 motori, per trattamenti viso, corpo e massaggi. Regolazione elettrica di altezza, schienale e gambe. Materasso rivestito in PVC, ignifugo e resistente agli olii. Braccioli abbattibili con pompa-gas. Basamento verniciato grigio chiaro con illuminazione Led in RGB sotto la base. Colonne rivestite in plexiglass fumè.

OPTIONAL: opzione Thermic



DIMENSIONI (mm)

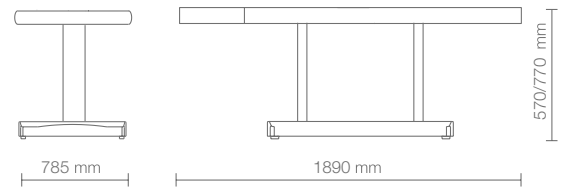

FINITURE

Struttura Cashmere



MOTORI

4



Up & Down Mover

Sensus Cabinet Lettino Elettrico

Lettino multifunzione 4 motori, per trattamenti viso, corpo e massaggi. Regolazione elettrica di altezza, schienale e gambe. Base e mobile con cassettoni in melaminico finitura sabbia opaco (cashmere). Meccanismi, telaio, colonne e materasso standard Sensus.

OPTIONAL: opzione Thermic



- ARRNI-N9032PL

DIMENSIONI (mm)

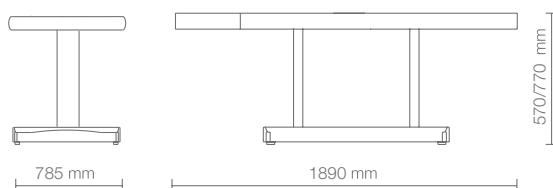



Letting Sensus
Sgabello Sunshine Easy



Letting Sensus Cabinet
Sgabello Sunshine Easy
Mobile Horizon



Up & Down



• ARRI-N92872

FINITURE

Rovere chiaro



Noce



Rovere sbiancato



MOTORI

4

Ninfea Lettino Elettrico

Lettino multifunzione 4 motori, per trattamenti viso, corpo e massaggi. Regolazione elettrica di altezza, schienale e gambe. Materasso rivestito in PVC, ignifugo e resistente agli olii. Struttura metallica rivestita in legno incurvato. Dotato di cassettoni portaccessori.

OPTIONAL: opzione Thermic



DIMENSIONI (mm)

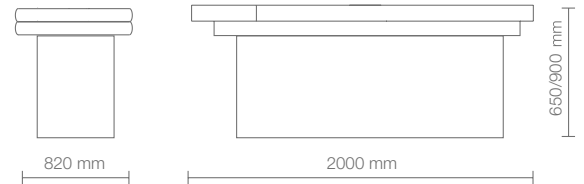

FINITURE

Wengè



Grigio



MOTORI

4



Mover

Iris Lettino Elettrico

Lettino multifunzione 4 motori, per trattamenti viso, corpo e massaggi. Regolazione elettrica di altezza, schienale e gambe. Materasso rivestito in PVC, ignifugo e resistente agli olii. Braccioli abbattibili con pompa-gas. Struttura metallica rivestita in legno. Vano inferiore dotato di prese d'aria per alloggiamento elettrici, con vetri scorrevoli in plexiglass antiurto fumè.

OPTIONAL: opzione Thermic



• ARRI-N90374

DIMENSIONI (mm)

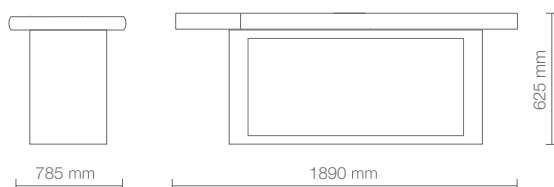



Lettino Ninfea
Sgabello Aloe
Mobile Kiwi



Lettino Iris

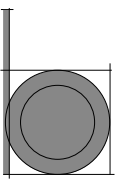

• ARWE-2256



FINITURE

Struttura Legno naturale



MOTORI

3



Up & Down 0° to 70° 0° to 25°

Moku Lettino Elettrico

Lettino multifunzionale ad alte prestazioni dotato di 3 motori che controllano l'altezza e l'inclinazione dello schienale e dello snodo centrale. Foro facciale, struttura metallica a forbice con finitura in legno naturale. Imbottitura di alta qualità con rivestimento in PU bianco di alta qualità.

DIMENSIONI (mm)

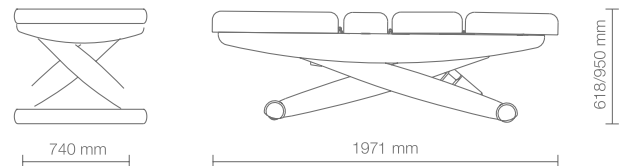

FINITURE

Legno naturale



Wengé



MOTORI

4



Up & Down 0° to 65° 0° to 25°

Monkie Lettino Elettrico

Lettino a 4 motori che regolano l'altezza e l'inclinazione dello schienale, del poggiatesta e dell'intero lettino. Materasso tutto d'un pezzo a 3 sezioni. Braccioli regolabili e e parte superiore dotata di foro facciale. Struttura metallica con finitura in legno color naturale o wengé. Imbottitura ad alto comfort con rivestimento in PU bianco di alta qualità.



• ARWE-2259 - legno



• ARWE-2259+BB - wengé

DIMENSIONI (mm)

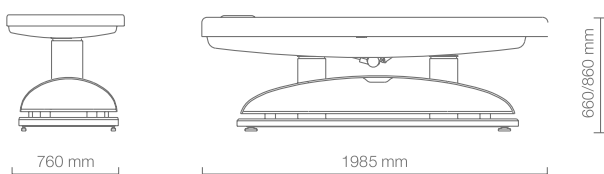

Lettino Moku



Lettino Monkie



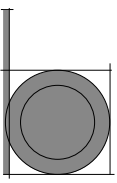

FINITURE

Struttura Cromata



MOTORI

3



Up & Down 0° to 65° 0° to 25°



- ARWE-2264.3



Kleim Lettino Elettrico

Lettino con 3 motori che regolano l'altezza e l'inclinazione di schienale e poggiatesta. Comoda imbottitura con rivestimento in PU bianco di alta qualità. Materasso monopezzo a 3 sezioni. Braccioli regolabili e testiera con foro facciale. La base include un sistema di illuminazione a LED di colore intercambiabile, per adattarlo al meglio in ogni singolo centro.

DIMENSIONI (mm)

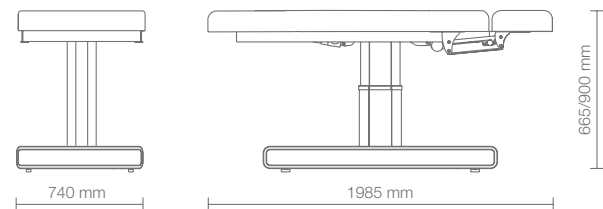

FINITURE

Struttura Cromata



MOTORI

4



Up & Down 0° to 65° 0° to 25°

Helvetia Lettino Elettrico

Lettino con 4 motori che regolano l'altezza e l'inclinazione dello schienale, del poggiatesta e dell'intero lettino. Comoda imbottitura con rivestimento in PU bianco di alta qualità. Materasso monopezzo a 3 sezioni con riscaldamento. Braccioli e testiera regolabili con foro facciale. La base include un sistema di illuminazione LED a colori intercambiabile che può essere adattato a ciascun centro.

DIMENSIONI (mm)

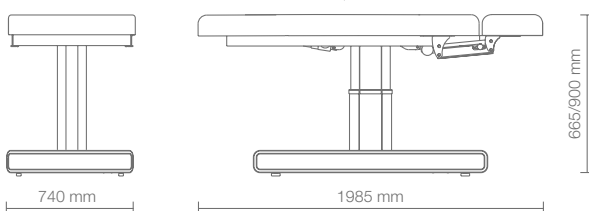

- ARWE-2275+.4



Lettino Kleim



Lettino Helvetia

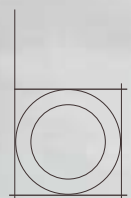
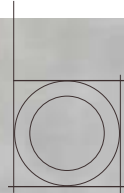

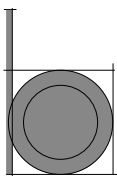

• ARWE-2212



FINITURE

Bianco



Nero



MOTORI

1



Up & Down 0° to 45°

Auriga Lettino Elettrico

Letto a 1 snodo dalla struttura metallica molto stabile, dotato di 1 motore che controlla l'altezza. L'inclinazione dello schienale è regolabile con un pistone a gas. Facile spostamento tramite due ruote incorporate. È dotato di un foro facciale, cuscino poggiatesta estraibile e portarotolo. Rivestimento in PVC bianco di gran qualità e facile pulizia.

DIMENSIONI (mm)

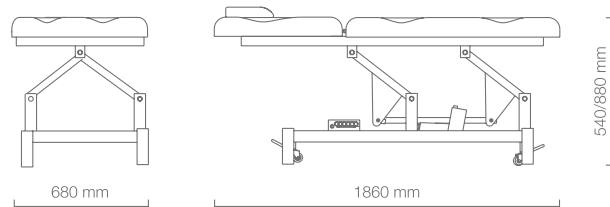

FINITURE

Bianco



Grigio scuro



MOTORI

1



Up & Down 0° to 75°

Boote Lettino Elettrico

Letto a 1 snodo dalla struttura molto stabile e dal design minimalista. È fornito di 1 motore per regolare l'altezza. L'inclinazione dello schienale è regolabile con un pistone a gas. Telaio metallico con base a forma di semisfera e 2 ruote incorporate che ne facilitano lo spostamento. Rivestimento in PU bianco di alta qualità e facile. Portarotolo incluso.

DIMENSIONI (mm)

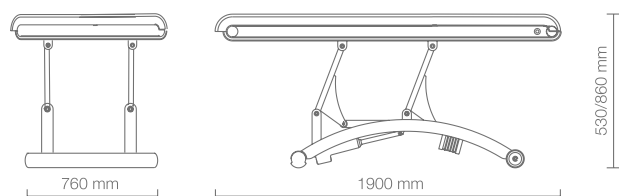

• ARWE-2241



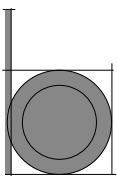

• ARWE-2241C



FINITURE

Bianco



Grigio scuro



MOTORI

3



Up & Down 0° to 75°

Carena Lettino Elettrico

Letto di alta gamma dotato di 3 motori che regolano l'altezza, l'inclinazione dello schienale e il modulo centrale. Braccioli fissi regolabili con un pistone a gas ed estraibili. Schienale con foro facciale e cuscino posturale addizionale. Robusto telaio metallico a forma di semisfera con due ruote per un facile spostamento. Rivestimento in PU facile da pulire e disponibile anche in grigio scuro. Portarotolo incluso.

DIMENSIONI (mm)

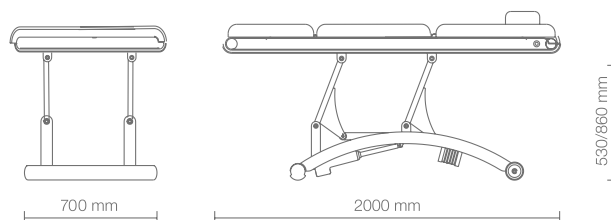

FINITURE

Bianco



MOTORI

3



Up & Down 0° to 80° 0° to -20°

Cefeo Lettino Elettrico

Letto ad alte prestazioni dotato di 3 motori per regolare l'altezza, l'inclinazione dello schienale e il segmento centrale. Braccioli regolabili e poggiatesta con foro facciale, cuscino posturale addizionale. Struttura metallica con ruote retrattili per un facile spostamento. Rivestimento in PU bianco di grande qualità e facile pulizia. Portarotolo compreso.

DIMENSIONI (mm)

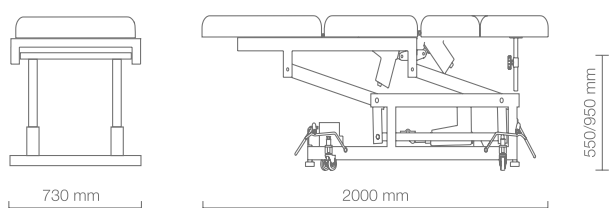

• ARWE-2234A



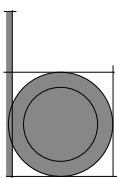

• ARWE-2247T.1



FINITURE

Bianco



Grigio scuro



MOTORI

1



Up & Down 0° to 75°

Herny Lettino Elettrico

Lettino multifunzionale a 2 sezioni dal design elegante. Dotato di 1 motore che regola l'altezza mediante una pulsantiera integrata nel telaio. L'inclinazione dello schienale è regolabile attraverso un pistone a gas. Rivestimento bianco in PU di gran qualità e facile da pulire. Portarotolo incorporato.

DIMENSIONI (mm)

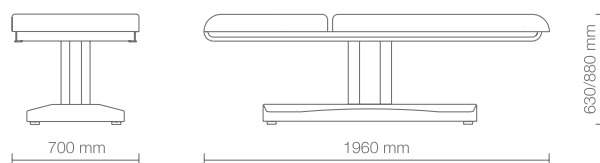



LETTINI TERMALI

Beauty Spa



www.beautyprogress.net

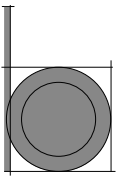

Andromeda Hydro & Mover

FINITURE

Laccato bianco opaco



Wengé



Cromorelax



Andromeda Hydro Lettino ad acqua

Diamo il benvenuto a chi ricerca un nuovo equilibrio vitale, il lettino con materassino ad acqua che stimola la mente, rilassa l'animo e rigenera il corpo, grazie ad un dolce massaggio. Distenditi e goditi il relax che deriva da una combinazione di colori... energia, vitalità ed armonia. Il materasso ad acqua incorpora la funzione di cromorelax con possibilità di scelta della temperatura che rigenera il corpo e lo spirito con un avvolgente tepore.

DIMENSIONI (mm)

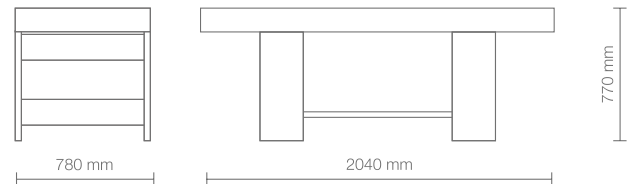

• ARCO-BPLAHB - bianco

• ARCO-BPLAHW - wengé

FINITURE

Laccato bianco opaco



Wengé



Up & Down



Cromorelax

Andromeda Hydro Mover Lettino ad acqua Elettrico

Andromeda Hydro Mover è un lettino multifunzionale con materassino ad acqua, unico nel suo genere. La temperatura può variare da 30° a 42° ed incorpora la funzione cromorelax. Mover è un sistema di sollevamento elettrico che permette di raggiungere un'altezza massima di 79 cm ed una minima di 57 cm, per un perfetto comfort dell'operatrice.

DIMENSIONI (mm)

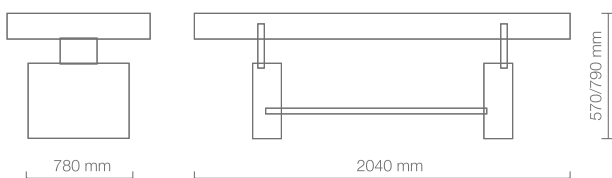

• ARCO-BPLAHMB - bianco



• ARCO-BPLAHMW - wengé



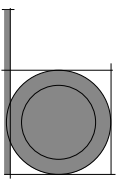

FINITURE

Struttura Bianco



MOTORI

1



Up & Down

Venus Easy Lettino ad acqua Elettrico

Lettino sensoriale ad 1 motore regolabile elettricamente in altezza e dedicato ai trattamenti wellness e relax con cuscini ad acqua. Dotato di vasca riscaldata (a 48 volt), faretti led-rgb con comandi digitali in pannello vetro touch. Struttura metallica rivestita in colore bianco.

- **ARRNI-N9022**

DIMENSIONI (mm)

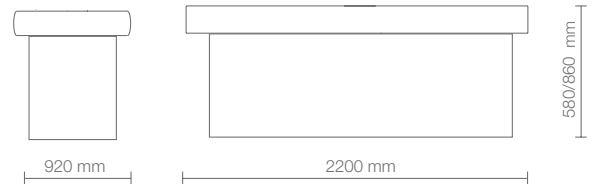

FINITURE

Struttura Bianco



MOTORI

1



Up & Down

Himalay Lettino sale Elettrico

Lettino sensoriale ad 1 motore regolabile elettricamente in altezza e dedicato ai trattamenti wellness e relax con sale Himalayano. Dotato di vasca riscaldata (a 48 volt), faretti led-rgb con comandi digitali in pannello vetro touch. Struttura metallica rivestita in colore bianco.

DIMENSIONI (mm)



- **ARRNI-N9024**

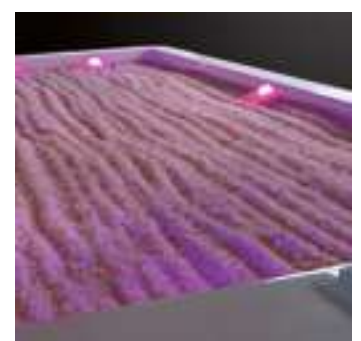
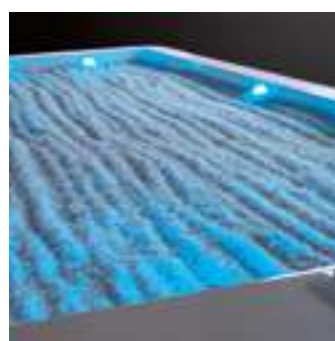

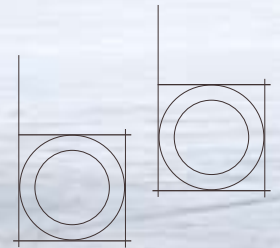

Lettino Venus Easy



Lettino Himalay

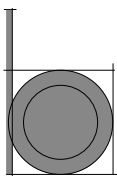

• **ARRNI-N9020**

FINITURE

Struttura Bianco



MOTORI

1



Up & Down

Wet Table Lettino multifunzione

Letentino multifunzione per trattamenti SPA-caldo-umidi, con vapore ed aromi (su piano in corian ospedaliero, facilmente igienizzabile) e trattamenti classici (con materassino neoprene). Struttura metallica bianca. Dotato di led-RGB con comandi digitali in pannello vetro touch. Materassini pieghevoli e riponibili sotto vasca per trattamenti asciutti. Serbatoio aromi, doccia estensibile e utenza a pavimento.



DIMENSIONI (mm)



FINITURE

Acero sbiancato



Wengé



Sayuri Chaise Lounge

Chaise Lounge in multistrato di Betulla tinto Wengé o Acero sbiancato, materasso Skai color testa di moro o bianco. Poggiapiedi estraibile.

DIMENSIONI (mm)

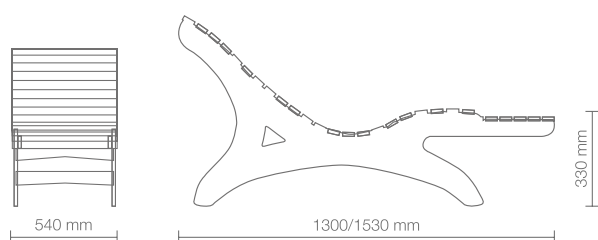

• **ARCO-BPCSAS** - acero

• **ARCO-BPCSW** - wengé





Lettino Wet Table



Lettino Sayuri

05

G f @ p v
www.beautyprogress.net

POLTRONE

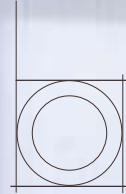
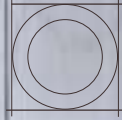

TORNA ALL'INDICE



POLTRONE FISSE

Podologia & Trattamenti



www.beautyprogress.net

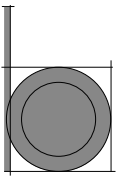

FINITURE

Bianco lucido



skai colors



- ARCO-BPPSBW

Saint Barth Poltrona Podologica

Podo Saint Barth, unica del suo genere si distingue per la sua forma ergonomica più ampia e confortevole. Maggiore ampiezza è stata regalata anche ai braccioli e alle relative vaschette removibili per manicure. La rotazione della sedia avviene all'incirca di 90° per agevolare seduta e discesa. La vasca, dotata di miscelatore e doccia, è realizzata in materiale compatto bianco ed è facilmente igienizzabile. Il rivoluzionario massaggio ad aria garantisce un piacevole momento rilassante e richiede una sporadica manutenzione. L'ampio poggiatesta è regolabile in profondità.

OPTIONAL: cromorelax

DIMENSIONI (mm)

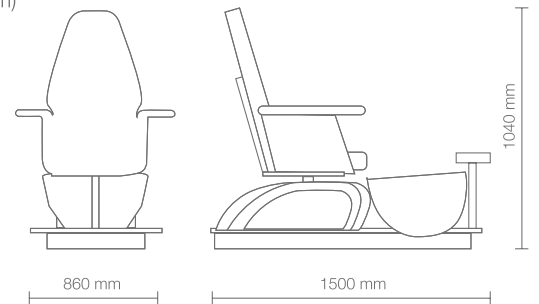

FINITURE

skai colors

Pacific Poltrona Podologica

La poltrona Pacific, con schienale, seduta e braccioli imbottiti, ha sotto di sé un cassetto nascosto con pannello frontale imbottito che può essere aperto, al cui interno si trova una vasca in acciaio inox estraibile per trattamenti pedicure. Attaccato al pannello frontale c'è un poggiatesta imbottito regolabile in altezza che offre una soluzione semplice e funzionale. Il meccanismo di reclinazione manuale dello schienale, aggiunge comfort per il cliente.

OPTIONAL: poggiamani con vaschetta manicure

DIMENSIONI (mm)

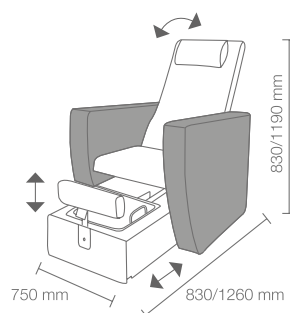

COLOURS A ○ B ●



- ARMB-MB/PC150



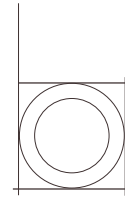
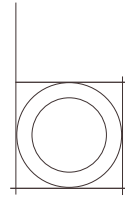

Poltrona Saint Barth
Sgabello Easy



Poltrona Pacific
Sgabello Texas

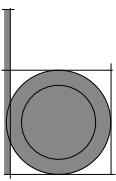

FINITURE

skai colors



Atlantis Poltrona Podologica

La poltrona Atlantis garantisce praticità e stile. Larga e completamente tappezzata è stata progettata per offrire il massimo del comfort: ruotando di 90° assicura la facilità d'uso tanto da parte del cliente quanto da parte dell'operatore. L'elegante poltrona poggia su una struttura rettangolare ricoperta in acciaio inox sulla quale è collocata una vasca per pedicure in Tecnopolimero bianco, completa di mixer, doccia, sistema di scarico a pavimento e poggipiedi imbottito regolabile in altezza e in avanti e indietro.

OPTIONAL: poggiamani con vaschetta manicure / massaggio Shiatsu

- ARMB-MB/PC250
- ARMB-MB/PC260 - massaggio shiatsu



DIMENSIONI (mm)

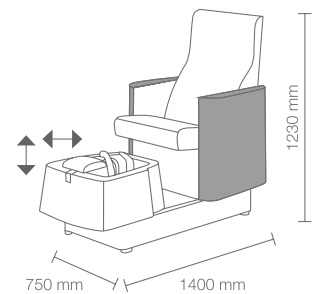

COLOURS A ○ B ●

FINITURE

skai colors



Cromorelax

Foot Basic Poltrona Podologica

Postazione pedicure dotata di regolazione guide mediante scorrimento e braccioli apribili per accesso e discesa cliente. Struttura metallica. Basamento e seduta rivestiti in PVC, ignifugo e resistente agli olii. Vasca dotata di doccia. Poggipiede regolabile in altezza. Scarico a pavimento.

OPTIONAL: idromassaggio e cromoterapia

DIMENSIONI (mm)

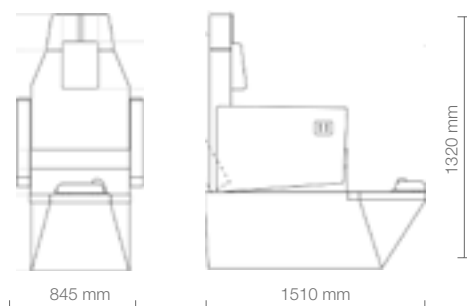

- ARRNI-N89922





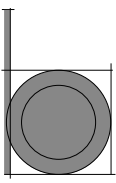

FINITURE

skai colors



- ARMB-MB/PC160



Prestige Poltrona Podologica

Ideata per trattamenti pedicure e manicure, con Prestige hai tutto ciò che serve in un unico prodotto. Un cassetto estraibile e imbottito nasconde una vasca podologica in acciaio inox. I braccioli imbottiti sono completi di due piattini di lavoro specifici per trattamenti manicure. Grazie allo schienale reclinabile e al poggiatesta regolabile in altezza, i tuoi clienti potranno abbandonarsi ad un momento di estremo relax durante il trattamento.

DIMENSIONI (mm)

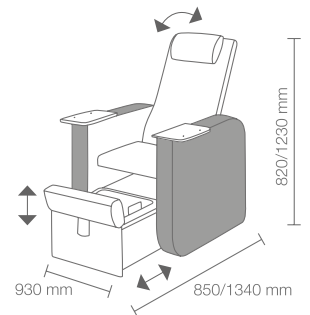

COLOURS A○B●

FINITURE

skai colors

Oasis Poltrona Podologica

Oasis, dai materiali completamente Made in Italy ha una forma accattivante della base in Laminato bianco e crea uno spazio perfetto per il relax. Lo stile semplice ed elegante della vasca rimovibile Pool crea una perfetta simmetria con la straordinaria comodità della poltrona, montata su una pompa idraulica. Il poggiatesta che è regolabile sia orizzontalmente che verticalmente completa Oasis, così potete offrire un servizio di pedicure completo in uno spazio ridotto!

DIMENSIONI (mm)

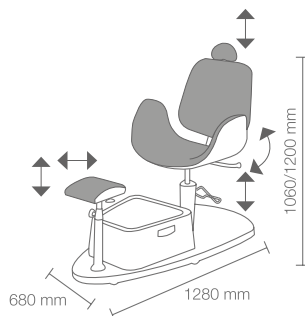

COLOURS A○B●



- ARMB-MB/PC200





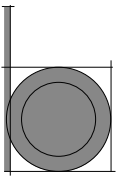

Edge & Mini Island Evo

FINITURE

Basamento cemento



skai colors



Edge Poltrona Podologica

Edge è una moderna poltrona podologica dalla linea sinuosa. Dotata di ampia e comoda seduta personalizzabile con 14 colori Skai. La salita e la discesa sono agevolate dal sollevamento dei braccioli. Il poggiatesta è regolabile in altezza. Il nuovo basamento è caratterizzato da un effetto materico color cemento. La nuova vaschetta per trattamenti pedicure è dotata di doccetta e miscelatore. Il morbido poggia piedi è regolabile sia in altezza che in profondità. Necessita allacciamento alla rete idrica.

• ARCO-PPE



DIMENSIONI (mm)

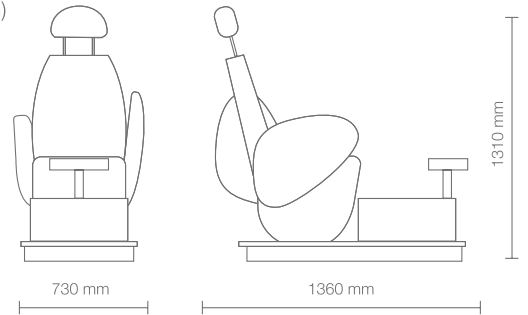

FINITURE

Rovere bardolino



Larice bianco



Mini Island Evo Poltrona Podologica

La poltrona Podologica Mini Island Evo, regala comfort grazie alla sua versatilità. Seduta regolabile in altezza, rotazione a 360°, schienale reclinabile con poggiatesta e due comode vaschette per manicure. La vasca pedicure è removibile per un comodo caricamento dell'acqua. Il poggia piedi funzionale è regolabile in altezza e profondità. Il basamento è in multistrato con bordatura in micro lamina d'acciaio spazzolato. Il pianale antigraffio è disponibile in Larice bianco e Rovere Bardolino.

OPTIONAL: rialzo

DIMENSIONI (mm)

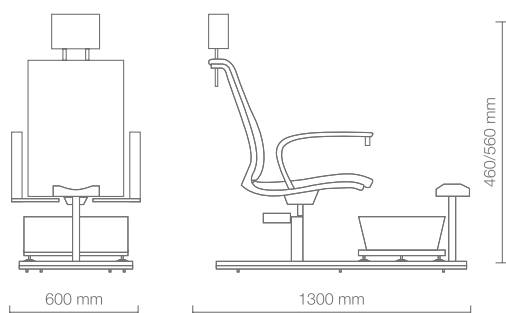

• ARCO-BPPMIELB - larice

• ARCO-BPPMIERB - rovere





Poltrona Edge
Mensole Stratos

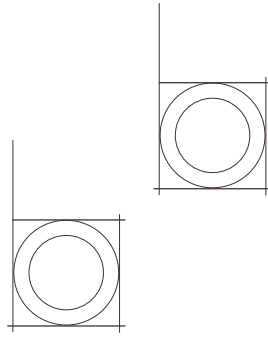

Poltrona Mini Island Evo
Sgabello Easy
Mobile Et-No H20

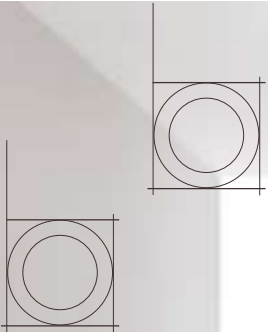

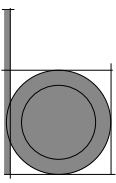

FINITURE

Struttura Bianco



Panna



• ARWE-WK-S019



Levante Poltrona Podologica

Poltrona pedicure con vaschetta e poggiatesta regolabile in altezza e lunghezza. Altezza e rotazione della poltrona regolabile con pompa idraulica e sistema di bloccaggio. Capacità: 10 Litri. Rivestimento in PU e facile da pulire.

DIMENSIONI (mm)

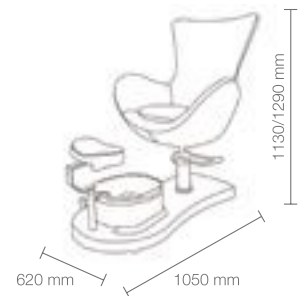

FINITURE

Bianco



Grigio scuro



0° to 70°

Bellevue Poltrona Podologica

Poltrona per pedicure dal design comodo ed elegante con rivestimento in PU bianco o nero di alta qualità. L'inclinazione dello schienale è regolabile tramite un pistone a gas. Dispone di un vano rimovibile situato sotto il sedile, che permette di posizionare una ciotola per pedicure. Poggiatesta regolabile.

DIMENSIONI (mm)

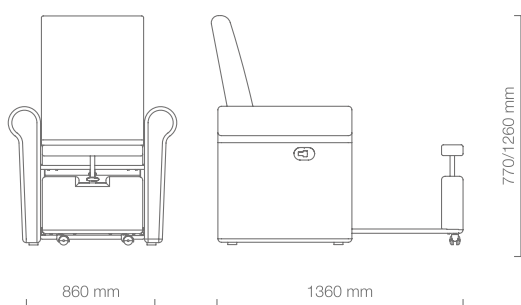

• ARWE-4200



Poltrona Bellevue
Colori Bianco



Poltrona Bellevue
Colori Nero



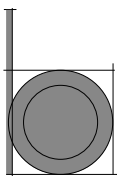

FINITURE

Struttura Bianco



• ARWE-WK-S004

Bora Poltrona Podologica

Sedia da pedicure con vaschetta per i piedi e poggiatesta girevole e regolabile in altezza. Altezza e rotazione della sedia regolabili mediante pompa idraulica e sistema di bloccaggio. Tappetino antiscivolo. Capacità: 10 Litri. Rivestimento in PVC bianco facile da pulire.

DIMENSIONI (mm)

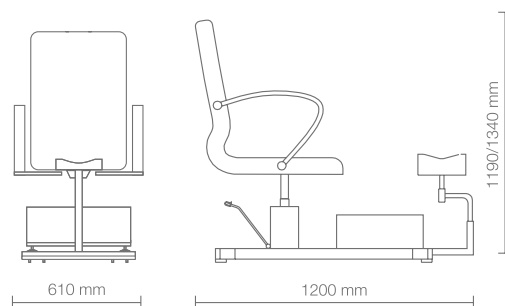

FINITURE

Struttura Cromata



Noe Poltrona Podologica

Poltrona podologica girevole con base cromata. Regolabile in altezza con una pompa idraulica con sistema di bloccaggio. Schienale e gambali regolabili indipendentemente con un pistone a gas. Rivestimento in PU bianco di alta qualità senza cuciture e facile da pulire.

DIMENSIONI (mm)

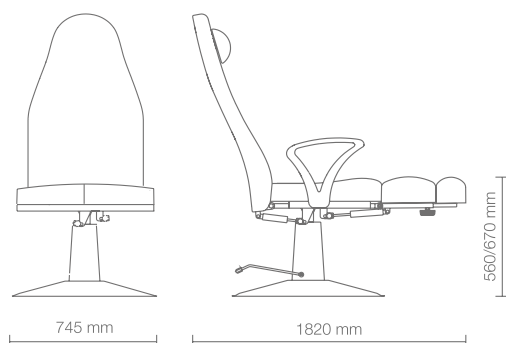

• ARWE-2231A



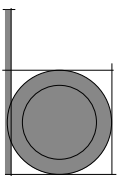

FINITURE

Struttura Bianco



0° to 63° 0° to 50°

Vortex Poltrona Idraulica

Poltrona funzionale a 3 corpi con pompa idraulica che consente di regolare l'altezza. L'inclinazione dello schienale e del poggiatesta viene regolata manualmente. Braccioli rimovibili. Rivestimento in PVC bianco di alta qualità e facile da pulire. Portarotolo compreso.

DIMENSIONI (mm)

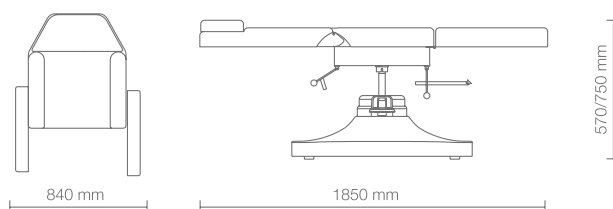

• ARWE-WK-E016

FINITURE

Bianco



Nero



0° to 63° 0° to 50°

Nepal Poltrona Idraulica

Poltrona a 2 snodi dalla struttura metallica verniciata. Altezza regolabile tramite una pompa idraulica. L'inclinazione dello schienale e del gambale è regolabile manualmente. Braccioli estraibili. Rivestimento in PVC bianco o nero facile da pulire.

DIMENSIONI (mm)

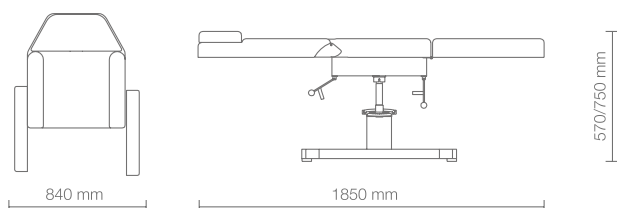

• ARWE-WK-E002



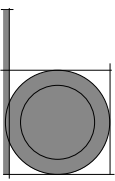

FINITURE

Bianco



Nero



0° to 65°



0° to 45°

Gange Poltrona Idraulica

Poltrona fissa a 3 sezioni dalla struttura metallica bianca o nera. Le inclinazioni dello schienale e del gambale si regolano manualmente. Braccioli e cuscino poggiatesta estraibili con foro facciale. Rivestimento in PVC bianco o nero facile da pulire.

DIMENSIONI (mm)

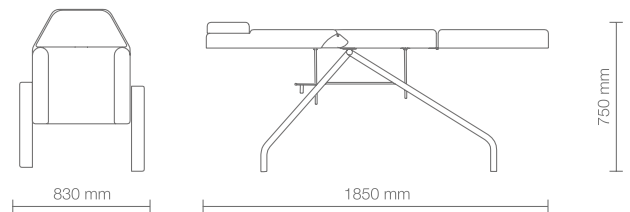

• ARWE-WK-E001

FINITURE

Struttura Bianco



CAPACITÀ

25 Litri

POTENZA

70w

Bubbles Vasca Podologia

Vaschetta da massaggio per i piedi. Ha piena mobilità grazie alle sue 4 ruote. Possibilità di scelta tra acqua fredda o calda. Dotata di una pratica doccia a getto regolabile. Idromassaggio e illuminazione LED nella vaschetta.

DIMENSIONI (mm)

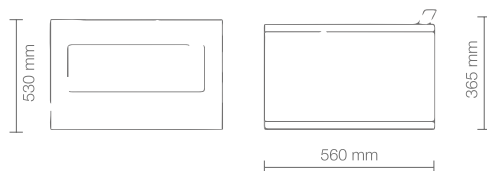

• ARMB-MB/V02

FINITURE

Struttura Bianco



Pool Vaschetta

Vaschetta da massaggio in Tecnopolimero bianco con maniglie laterali dalla forma trapezoidale.



• ARWE-4101



POLTRONE MOTORIZZATE

Podologia & Trattamenti



www.beautyprogress.net

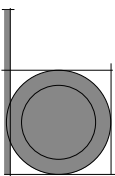

• ARWE-4122B

FINITURE

Bianco



Nero



MOTORI

2



SHIATSU
MASSAGE

Mali Poltrona Podologica Motorizzata

Poltrona pedicure dal design elegante ed ergonomico con rivestimento in PU di alta qualità. È dotata di due motori che regolano l'inclinazione dello schienale e lo spostamento del seduta. I braccioli sono girevoli con vaschetta manicure incorporata. Massaggio shiatsu alla schiena e massaggio ad aria a pressione nella seduta. Vaschetta per i piedi con idromassaggio e doccia. Equipaggiata con lettore MP3, spina USB e scheda SD.

DIMENSIONI (mm)

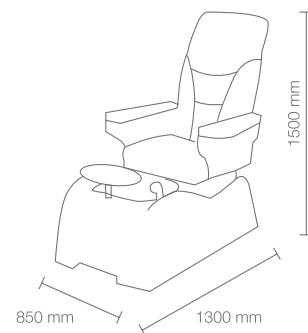

FINITURE

Struttura Bianco



MOTORI

2



Cromorelax

Space Light Poltrona Podologica Motorizzata

Poltrona pedicure dal design confortevole ed elegante con rivestimento in PU bianco di alta qualità. È dotata di due motori che ne regolano l'inclinazione dello schienale e lo spostamento della seduta tramite una pulsantiera integrata nel bracciolo. I suoi braccioli girevoli facilitano l'accesso alla poltrona. Vaschetta con idromassaggio, doccino e luce LED. Poggiatesta regolabile manualmente in altezza.

DIMENSIONI (mm)

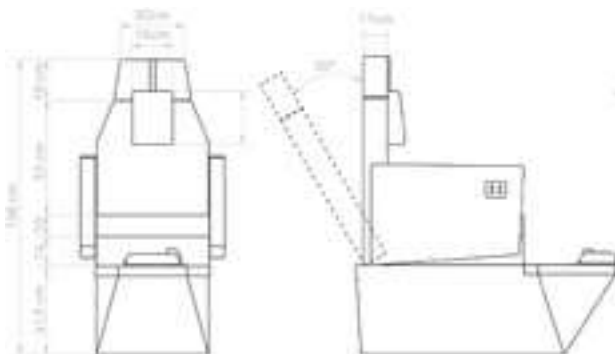

• ARWE-4128



Poltrona Space



Poltrona Space



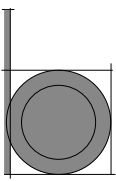

Soprano & Foot Dream



• ARRNI-P89942

FINITURE

Bianco



Nero



MOTORI

1



Cromorelax

Soprano Easy Poltrona Podologica Motorizzata

Poltrona multifunzionale, motorizzata, brevettata. Specifica per: make up, trattamenti viso, manicure e pedicure. Regolazione elettrica schienale. Appoggiatesta estraibile. Struttura metallica. Materasso rivestito in pvc, ignifugo e resistente agli oli. Vasca dotata di idromassaggio con sistema pipe-free, doccetta e cromoterapia. Scarico a pavimento. Struttura nero o bianco. Parte sottomano bracciolo in corian, apribile, con cassetto all'interno

DIMENSIONI (mm)

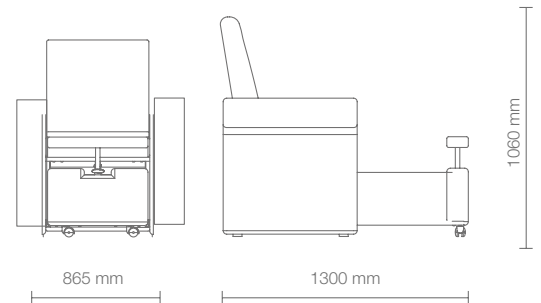

FINITURE

Rovere chiaro



Rovere sbiancato



Noce



MOTORI

2



SHIATSU
MASSAGE



Cromorelax

Foot Dream Luxury Poltrona Podologica Motorizzata

Postazione pedicure dotata di 2 motori per regolazione posizione sedile e schienale, attivazione massaggio shiatsu schienale. Struttura metallica rivestita in legno con spigoli arrotondati. Seduta rivestita in PVC, ignifugo e resistente agli oli. Braccioli apribili per accesso e discesa cliente. Cuscini appoggiapiedi regolabili ed estraibili. Vasca dotata di idromassaggio con sistema Pipe-free, doccetta e cromoterapia. Scarichi a pavimento o a parete.

DIMENSIONI (mm)

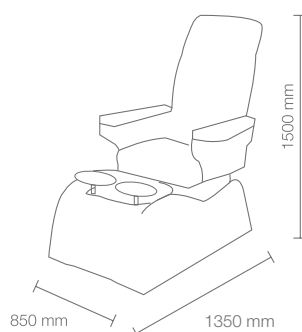

• ARRNI-N89991

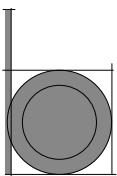

FINITURE

Bianco



skai colors

MOTORI

4



0° to 80°



0° to 85°



• ARRNI-N94461



Alabama Poltrona Trattamenti Motorizzata

Poltrona multifunzione 4 motori per trattamenti viso, corpo e trucco. Regolazione elettrica di altezza, schienale, gambe e bascula (trendelenburg). Materasso rivestito in skai, ignifugo e resistente agli oli. Braccioli ribaltabili ed estraibili. Appoggiatesta e appoggiapiedi regolabili ed estraibili. Inclinazione schienale 80°. Foro viso incluso. Struttura in acciaio verniciato e ABS.

DIMENSIONI (mm)



FINITURE

Bianco



skai colors

MOTORI

3



0° to 80°



0° to 85°

Alabama Podo Poltrona Podologica Motorizzata

Poltrona Pedicure multifunzione 3 motori per trattamenti viso, corpo e trucco. Regolazione elettrica di altezza, schienale e bascula (trendelenburg). Materasso rivestito in skai, ignifugo e resistente agli oli. Braccioli ribaltabili ed estraibili. Gambale ruotante di 90° all'esterno. Appoggiatesta e appoggiapiedi regolabili ed estraibili. Inclinazione schienale 80°. Foro viso incluso. Struttura in acciaio verniciato e ABS.

DIMENSIONI (mm)



• ARRNI-N94461P



Poltrona Foot Dream Luxury
Sgabello Aloe

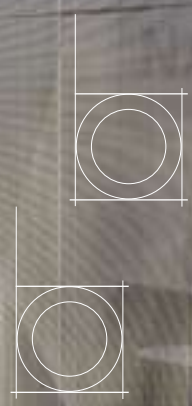

Poltrona Alabama
Sgabello Aloe

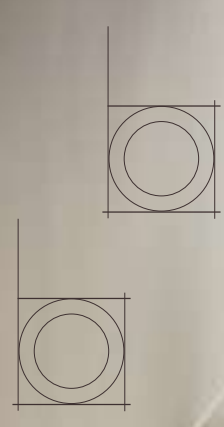

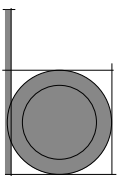

FINITURE

Struttura Bianco



MOTORI

1



0° to 40°



0° to 85°

Singapour Poltrona Podologica Motorizzata

Poltrona podologica dal design minimalista e 1 motore che regola l'altezza. Schienale e gambali indipendenti regolabili con pistone a gas. Cuscino poggiatesta removibile. Rivestimento in PVC bianco di alta qualità senza cuciture e facile da pulire.

DIMENSIONI (mm)

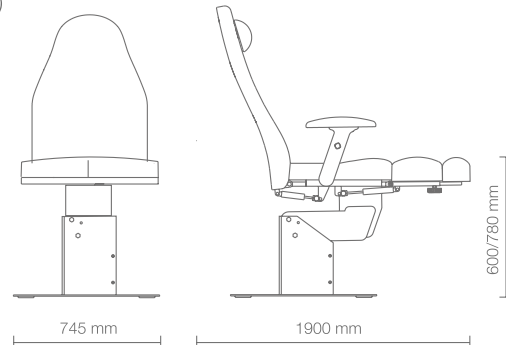

• ARWE-2232A

FINITURE

Struttura Bianco



MOTORI

3-5



240°
ROTATION



0° to 80°



0° to 85°

Moyce Poltrona Podologica Motorizzata

Poltrona podologica di alta gamma dotata di 3 motori che controllano l'altezza, l'inclinazione dello schienale e della seduta. Rotazione a 240° e gambali regolabili in maniera indipendente tramite dei pistoni a gas. Grazie alle pulsantiere integrate nello schienale, nella seduta e nei gambali è possibile controllare i movimenti da qualsiasi punto della poltrona. Braccioli removibili e reversibili e poggiatesta regolabile. Rivestimento in PU di alta qualità e di facile pulizia. Disponibile anche a 5 motori.

DIMENSIONI (mm)

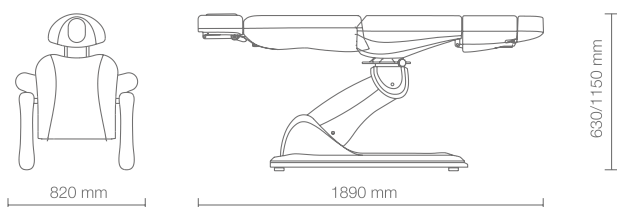

- ARWE-2246A - 3 motori
- ARWE-2246C - 5 motori



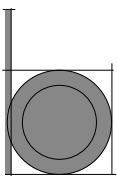

- **ARWE-2244A** - 3 motori
- **ARWE-2244C** - 5 motori

FINITURE

Bianco



Grigio scuro



MOTORI

3-5



0° to 85°



0° to 75°

Oxford Poltrona Podologica Motorizzata

Poltrona di podologia di alta gamma dotata di 3 motori che regolano l'altezza, l'inclinazione dello schienale e della seduta. Gambali regolabili in maniera indipendente tramite dei pistoni a gas e girevoli meccanicamente fino a 90°. Grazie alle pulsantiere integrate nello schienale, nella seduta e nei gambali è possibile controllare i movimenti da qualsiasi punto della poltrona. Rivestimento in PU di gran qualità senza cuciture e facile da pulire. Disponibile anche a 5 motori.

DIMENSIONI (mm)

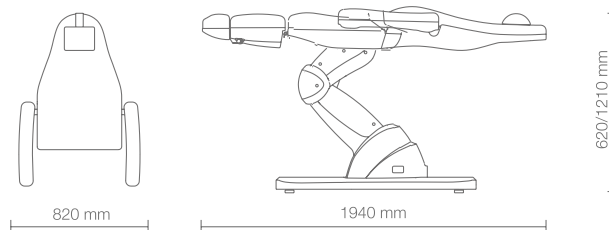

FINITURE

Struttura Bianco



MOTORI

3



0° to 85°



0° to 90°

Cambridge Poltrona Podologica Motorizzata

Poltrona podologica dalle alte prestazioni e struttura molto stabile, con 3 motori che controllano l'altezza, l'inclinazione dello schienale e l'inclinazione della seduta. Gambali regolabili in maniera indipendente tramite dei pistoni a gas che regolano l'altezza. Braccioli reversibili e poggiatesta regolabili. Rivestimento in PU bianco di alta qualità e di facile pulizia.

DIMENSIONI (mm)

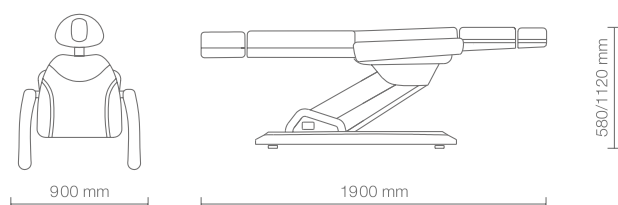

- **ARWE-2235C**

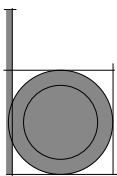

FINITURE

Struttura Bianco



MOTORI

3



0° to 75° 0° to 75°



• ARWE-2250A

Taurus Poltrona Podologica Motorizzata

Poltrona podologica di alta gamma dotata di 3 motori per la regolazione dell'altezza, l'inclinazione dello schienale e l'inclinazione della seduta. Braccioli ribaltabili ed estraibili, foro facciale e poggiatesta regolabile. Gambali regolabili in maniera indipendente tramite dei pistoni a gas che ne regolano l'altezza, e girevoli verso l'esterno fino a 90°. Grazie alle pulsantiere integrate nello schienale e nella seduta è possibile controllare i movimenti da qualsiasi punto della poltrona. Rivestimento in PU bianco di alta qualità e facile da pulire.

DIMENSIONI (mm)

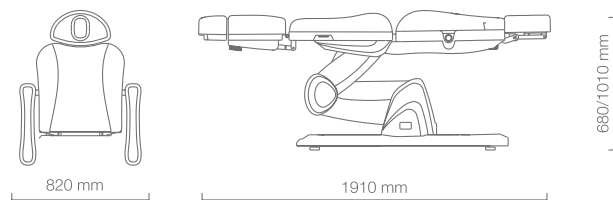

FINITURE

Nero



MOTORI

3



0° to 80° 0° to 80°

Plutone Poltrona Podologica Motorizzata

Poltrona podologica di alta gamma dotata di 3 motori che controllano l'altezza, l'inclinazione dello schienale e del sedile. Braccioli pieghevoli e cuscino poggiatesta regolabile in più posizioni preimpostate. Poggiapiedi regolabili in altezza in modo indipendente tramite pistone a gas e con apertura laterale in due posizioni preimpostate fino a 90°. Rivestimento grigio in PU di alta qualità e facile da pulire.

DIMENSIONI (mm)



• ARWE-WK-P005



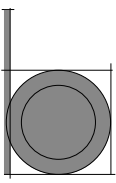

FINITURE

Bianco



Grigio scuro



MOTORI

3



0° to 63°



0° to 90°

Fusion Light Podo Poltrona Podologica Motorizzata

Poltrona podologica di alta gamma che si distingue per il suo design innovativo. Dispone di 3 motori che controllano l'altezza, l'inclinazione dello schienale e la seduta. Braccioli, poggiatesta e poggiatesta e poggiatesta pieghevoli e removibili. Gambali regolabili in maniera indipendente tramite dei pistoni a gas che ne controllano l'altezza. Struttura in acciaio molto stabile con luce LED bianca integrata nella base. Rivestimento in PU bianco o grigio di alta qualità.

DIMENSIONI (mm)

• ARWE-BLIGHT503

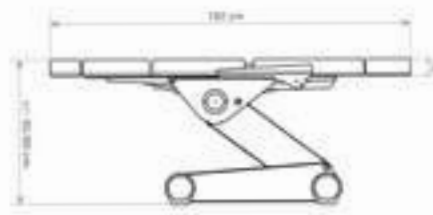

FINITURE

Bianco



MOTORI

4



0° to 63°



0° to 90°

Fusion Light Poltrona Trattamenti Motorizzata

Lettino di alta gamma, che si distingue per il suo design innovativo. Dispone di 4 motori che controllano l'altezza, l'inclinazione dello schienale, la seduta e il poggiatesta. Braccioli, poggiatesta e poggiatesta e poggiatesta pieghevoli e removibili. Struttura in acciaio molto stabile con luce LED bianca integrata nella base. Rivestimento in PU bianco di alta qualità.

DIMENSIONI (mm)

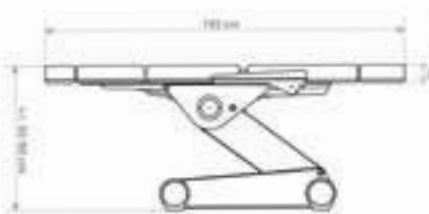

• ARWE-BLIGHT502



Poltrona Fusion Light Podo



Poltrona Fusion Light



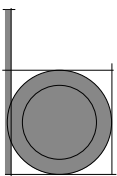

FINITURE

Bianco



Grigio scuro



MOTORI

3

Swoop P3 Pro Poltrona Podologica Motorizzata

Un lettino di podologia dotato di 3 motori che distacca per la sua ottima stabilità e la sua base ultra compatta. Completa di foro e cuscinetto facciale, luce LED bianca nel telaio, 4 ruote 360°. Rivestimento 100% Mix vinilico in bianco o grigio. Resistenza all'abrasione: >250.000 cicli. Protezione contro germi e raggi UV. Gambali separati. Set di 2 pannelli OAK incluso

DIMENSIONI (mm)

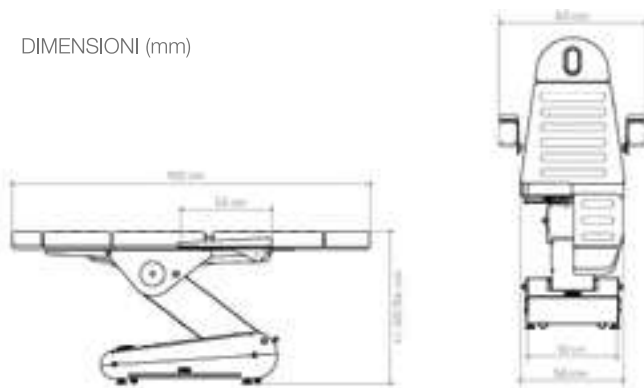

• ARWE-P3PRO



FINITURE

Bianco



MOTORI

4

Swoop B4 Pro Poltrona Trattamenti Motorizzata

Lettino d'alta gamma a 4 motori gestibili da telecomando, ottima stabilità e struttura ultracompatta. Completa di foro e cuscinetto facciale, luce LED bianca nel telaio, 4 ruote 360°. Rivestimento 100% Mix vinilico in bianco o grigio. Resistenza all'abrasione: >250.000 cicli. Protezione contro germi e raggi UV. Set di 2 pannelli OAK incluso.

DIMENSIONI (mm)

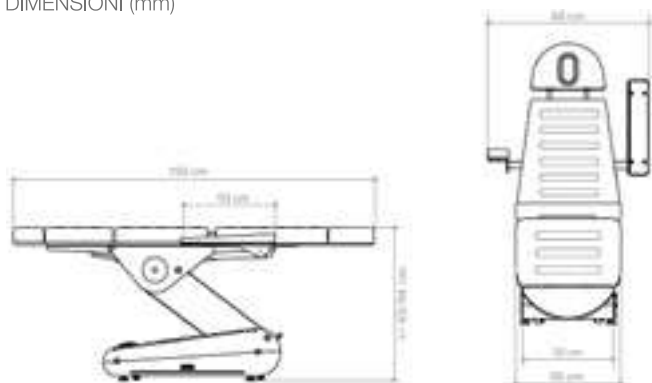

• ARWE-B4PRO





Nordic
METALLO

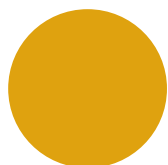

Yellow

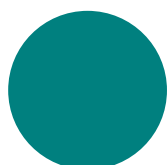

Blue

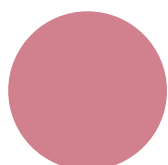

Pink

Foll
METALLO

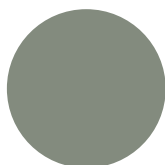

Ash

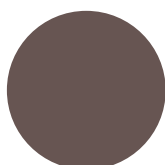

Clay

Iron
METALLO

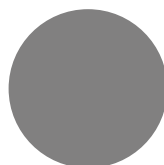

Inox

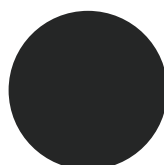

Black

Om
LEGNO



Oak



Wenge

Techno
PMMA



Fluor

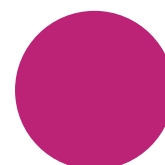

Fuxia



Ice

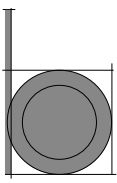

FINITURE

Struttura Bianco



MOTORI

3-4



0° to 85° 0° to 90°



Sixties Poltrona Trattamenti Motorizzata

Poltrona di alta gamma dotata di 3 motori che regolano l'altezza, l'inclinazione dello schienale e l'inclinazione della seduta. Gambale regolabile tramite pistone a gas, braccioli reclinabili ed estraibili e poggiatesta regolabile. Disponibile anche a 4 motori con regolazione del gambale. Grazie alle pulsantiere integrate nello schienale e nella seduta, è possibile controllare i movimenti da qualsiasi punto della poltrona. Include la funzione RST, che consente di ripristinare la posizione iniziale della poltrona. Rivestimento in PU bianco di alta qualità e facile da pulire.

- ARWE-2235B - 3 motori
- ARWE-2235D - 4 motori



DIMENSIONI (mm)

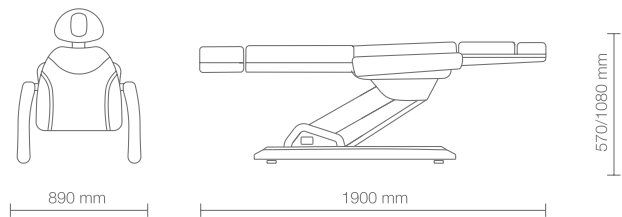

FINITURE

Bianco



Legno naturale



MOTORI

3-4



0° to 68° 0° to 50°

Stortz Poltrona Trattamenti Motorizzata

Poltrona d'estetica a 3 corpi con 3 motori che controllano l'altezza, l'inclinazione dello schienale e del poggiatesta. Braccioli pieghevoli e poggiatesta regolabile con foro fracciale. Disponibile anche con 4 motori che consentono la regolazione motorizzata del sedile. Rivestimento in PVC bianco facile da pulire. Portarotolo incluso.

DIMENSIONI (mm)

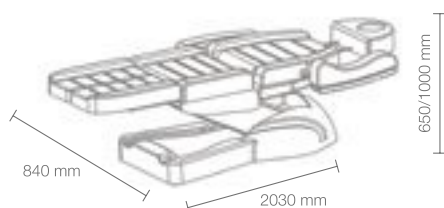

- ARWE-WK-E014 - 3 motori
- ARWE-WK-E015 - 4 motori

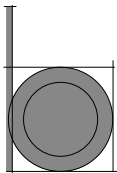

FINITURE

Struttura Bianco



MOTORI

3



0° to 85° 0° to 65°



• ARWE-2214A

Pillow Poltrona Trattamenti Motorizzata

Poltrona funzionale a 2 snodi, dalla struttura molto stabile. È dotata di 3 motori che regolano l'altezza, l'inclinazione dello schienale e del poggiatesta. Braccioli e cuscino poggiatesta estraibili e foro facciale. Rivestimento in PU bianco di alta qualità e facile pulizia.

DIMENSIONI (mm)

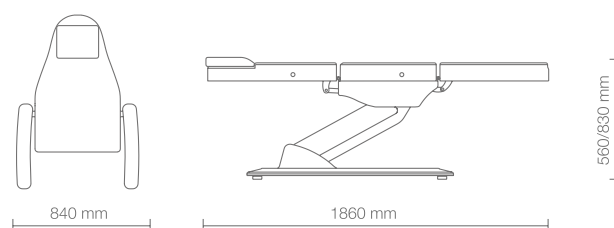

FINITURE

Struttura Bianco



Panna



MOTORI

3



0° to 70° 0° to 90°

Mosca Poltrona Trattamenti Motorizzata

Poltrona di alta gamma a 3 corpi con struttura molto stabile. Dotata di 3 motori che controllano l'altezza, l'inclinazione dello schienale e il poggiatesta. Braccioli pieghevoli e rimovibili. Con foro per il viso e cuscino poggiatesta regolabile. Rivestimento bianco in PU di alta qualità e facile da pulire.

DIMENSIONI (mm)

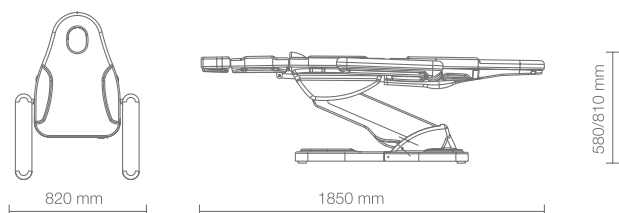

• ARWE-WK-E017



Poltrona Quadra



Poltrona Brent

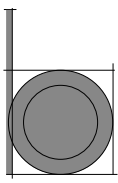

- ARWE-2246 - 3 motori
- ARWE-2246B - 4 motori



FINITURE

Struttura Bianco



MOTORI

3-4



ROTATION



0° to 80°



0° to 85°

Quadra Poltrona Trattamenti Motorizzata

Poltrona d'alta con rotazione della poltrona a 240°. Ha 3 motori che controllano l'altezza, l'inclinazione dello schienale e della seduta. Gambale regolabile tramite un pistone a gas, braccioli reclinabili ed estraibili. Disponibile anche a 4 motori con la regolazione del gambale. Grazie alle pulsantiere, integrate nello schienale, nella seduta e nel gambale, è possibile controllare e regolare i movimenti da qualsiasi punto della poltrona. Include la funzione RST, che consente di ripristinare la posizione iniziale della poltrona. Rivestimento in PU di alta qualità e facile da pulire.

DIMENSIONI (mm)

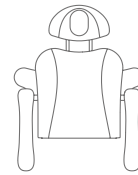

840 mm

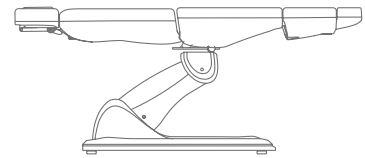

1900 mm

620/1150 mm

FINITURE

Struttura Bianco



MOTORI

3



0° to 85°



0° to 45°

Brent Poltrona Trattamenti Motorizzata

Poltrona d'alta gamma dallo stile minimalista e dall'elevato comfort. Dotata di 3 motori che regolano l'altezza, l'inclinazione dello schienale e della seduta. Poggiapiedi regolabile tramite pistone a gas. Grazie alle pulsantiere, integrate nello schienale e nella seduta, è possibile controllare i movimenti da qualsiasi punto della poltrona. Braccioli reclinabili ed estraibili. Rivestimento in PU bianco di alta qualità e di facile pulizia.

DIMENSIONI (mm)

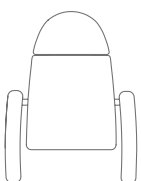

800 mm

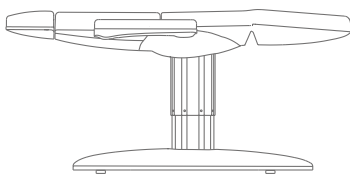

1880 mm

630/1180 mm



- ARWE-2240





POLTRONE MULTIFUNZIONE



www.beautyprogress.net

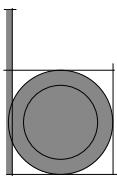

- ARMB-MB/P9 - con poggiatesta
- ARMB-MB/P8 - senza poggiatesta



FINITURE

skai colors



Marilyn Poltrona Multifunzione

Poltrona per trattamenti estetici dal design minimalista, con seduta e schienale formati da un'unica scocca, completa di pompa a gas e base a stella in alluminio con anello poggiatesta.

DIMENSIONI (mm)



COLOURS A ○ B ●

FINITURE

skai colors



Audrey Poltrona Multifunzione

Audrey è la monoscocca dal design futuristico. Realizzata in tecnopolimero bianco - resistente e leggero - è perfetta da abbinare al tavolo manicure, donando uno stile contemporaneo al tuo salone di bellezza. Nella versione con cuscino tappezzato in Skai, alla semplicità della struttura si aggiunge il tocco vivace di textures e colori diversi, per un prodotto di tendenza, funzionale e decorativo.

DIMENSIONI (mm)



- ARMB-MB/P18 - con cuscino
- ARMB-MB/P14 - senza cuscino



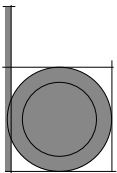

New Make-Up & Green Hug

FINITURE

skai colors



• ARCO-MUPMU

New Make-Up Poltrona Multifunzione

La poltrona make-up regala comfort grazie alla sua versatilità ed è estremamente curata in ogni particolare. Basamento cromato di ampie dimensioni, seduta regolabile in altezza, rotazione a 360°, schienale reclinabile con poggiatesta regolabile in altezza.

DIMENSIONI (mm)

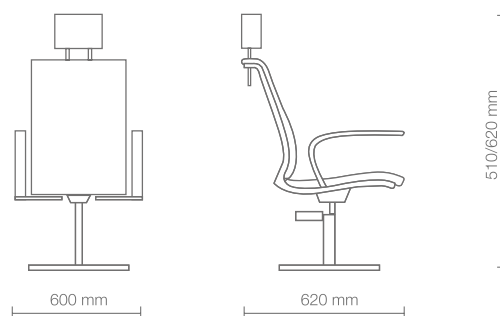

FINITURE

Rovere chiaro



Noce



skai colors



Green Hug Poltrona Multifunzione

Poltrona da lavoro girevole. Schienale in legno multistrato impiallacciato verniciato. Staffa reggi schienale in acciaio verniciato a polvere nero o cromato. Imbottitura in poliuretano espanso. Rivestimento in Skay.

DIMENSIONI (mm)

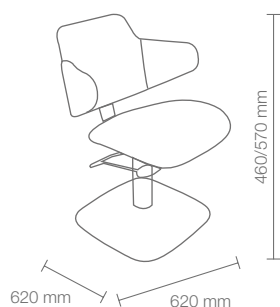

- ARRNI-P3175
- ARRNI-P37981 - con poggiatesta



Poltrona Natalie



Poltrona Eva



Poltrona Marilyn



Poltrona Audrey

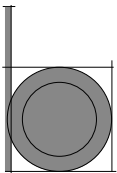

FINITURE

skai colors



ROTATION



Natalie Poltrona Multifunzione

Natalie è la poltroncina per make-up dal design rotondo e femminile. Questa poltrona professionale è composta da una seduta tonda e curvata imbottita e molto confortevole, abbinata ad uno schienale regolabile dotato di poggiatesta regolabile in altezza per il massimo comfort del cliente e dell'operatore. La poltroncina è completata da una base rotonda satinata con pompa bloccabile.

DIMENSIONI (mm)

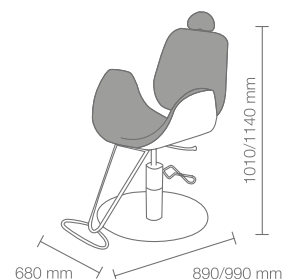

COLOURS A ○ B ●

- ARMB-MB/P15 - con poggiatesta
- ARMB-MB/P21

FINITURE

skai colors



ROTATION

Eva Poltrona Multifunzione

Eva è la poltrona make-up dal design dolcemente squadrato, carico di eleganza e femminilità, concepito per postazioni trucco moderne, dal tono giovane e attuale. Completa di poggiatesta cromato, schienale reclinabile, e poggiatesta imbottito.

DIMENSIONI (mm)

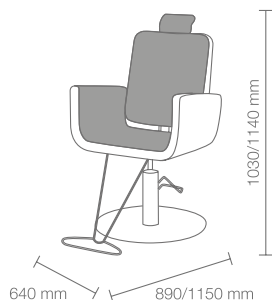

COLOURS A ○ B ●

- ARMB-MB/P24





MANICURE

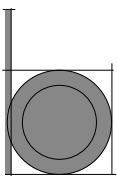

Living & Living Led

FINITURE

Struttura bianco opaco



Aspiratore
60W

Rovere bardolino



Larice bianco



• **ARCO-TLRB** - rovere



• **ARCO-TLLB** - larice

Living Tavoli Manicure

Tavoli manicure dalle dimensioni compatte realizzati in nobilitato bianco opaco dal piano tavolo disponibili in 3 diverse finiture. Con il tavolo Living è possibile avere una singola postazione o creare più postazioni di lavoro, personalizzandolo secondo le proprie esigenze grazie all'innovativo sistema componibile. Sono dotate di foro passacavi e offrono la possibilità di scegliere tra il piano di lavoro classico oppure con il foro per l'aspirazione.

Living Led inoltre è dotata di un modulo con illuminazione a led composto da mensole su cui è possibile esporre smalti e prodotti.

OPTIONAL: aspiratore



• **ARCO-TLLRB** - rovere

DIMENSIONI (mm)

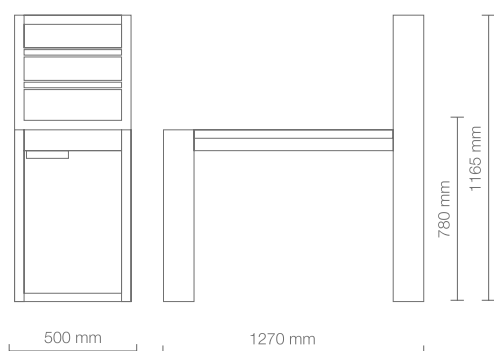

• **ARCO-TLLLB** - larice



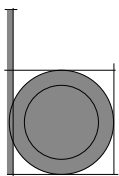

Hibiscus & Narciso



Aspiratore

FINITURE

Rovere sbiancato



Rovere chiaro



Noce



• **ARRNI-N83801**

Hibiscus Tavolo Manicure

Mobile manicure provvisto di cassetteria laterale con cinque cassetti push and pull. Struttura rivestita in legno con angoli arrotondati, con piano in vetro temprato serigrafato bianco. Completo di filtro anti odore a carboni attivi e lampada LED. Dotato di un sistema di aspirazione con doppia ventola per evitare che polvere e frammenti vengano dispersi nell'ambiente: questi vengono convogliati in un vasoio estraibile posto sotto la griglia, per venire infine rimossi definitivamente dall'operatore.

DIMENSIONI (mm)

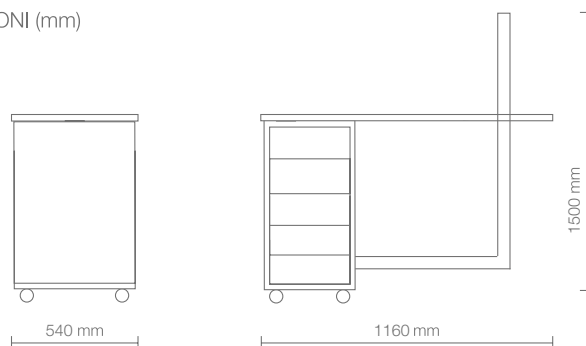

FINITURE

Struttura Bianco



Bianco



Rovere chiaro



Aspiratore

Narciso Tavolo Manicure

Tavolo manicure dotato di espositore laterale con 3 ripiani e illuminazione led. Fianchi disponibili in legno bianco o rovere chiaro e top bianco. Dotato di 2 vani lato cliente e 1 vano lato operatore.

OPTIONAL: aspiratore

DIMENSIONI (mm)

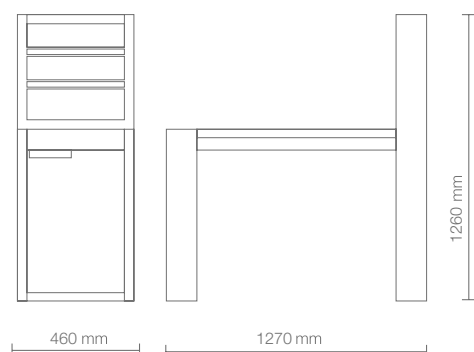

• **ARRNI-N8302**



Manicure Hibiscus
Sgabello Aloe
Poltrona Foot Dream Luxury



Manicure Narciso
Poltrona Green Hug



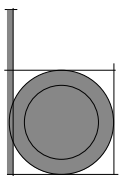

Allure & Allure Double

FINITURE

Struttura Nobilitato bianco



Aspiratore
30W



Aspiratore
60W



Allure Tavolo Manicure

Allure è un moderno e minimale tavolo manicure che combina una moderna struttura in Nobilitato bianco con un pannello laterale in plexi retroilluminato, caratterizzato dalla presenza di due ripiani in metacrilato per i prodotti; tutto ciò per offrire uno stile ed una funzionalità in un unico prodotto.

DIMENSIONI (mm)

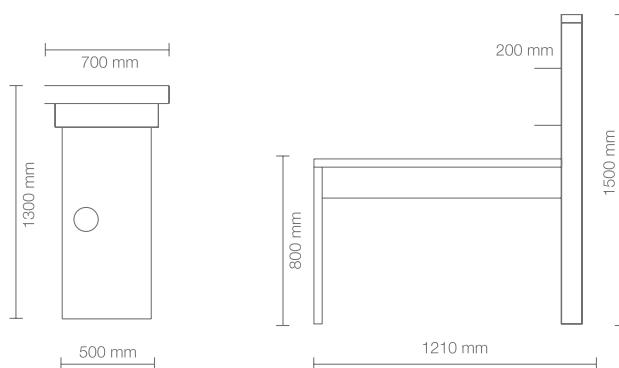

- ARMB-MB/MT120
- ARMB-MB/MT121 - con aspiratore 30W
- ARMB-MB/MT124 - con aspiratore 60W



FINITURE

Struttura Nobilitato bianco



Aspiratore
30W



Aspiratore
60W

Allure Double Tavolo Manicure

Allure Double è un moderno e minimale tavolo manicure che combina una struttura in Nobilitato bianco con due pannelli laterali in plexi retroilluminato, caratterizzati dalla presenza di due ripiani (per pannello) in metacrilato per inserire i prodotti; tutto ciò per offrire uno stile ed una funzionalità in un unico prodotto.

DIMENSIONI (mm)

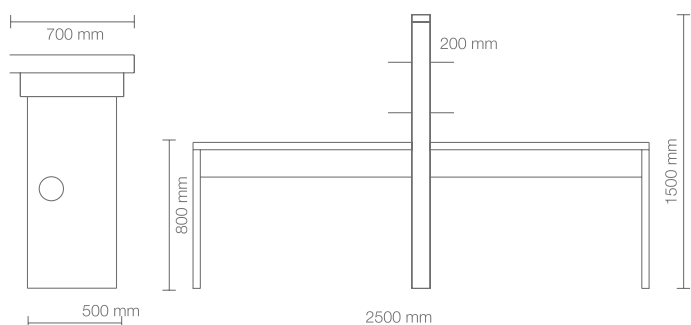

- ARMB-MB/MT122
- ARMB-MB/MT123 - con aspiratore 30W
- ARMB-MB/MT125 - con aspiratore 60W





Manicure Allure
Poltrona Audrey Skai
Sgabello Montana



Manicure Logic
Sgabello Montana e Arizona
Divanetto Miami

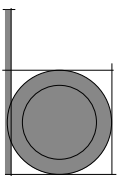

Logic & Logic Double

FINITURE

Struttura Nobilitato bianco



Aspiratore
30W



Aspiratore
60W



Logic Tavolo Manicure

Ampio tavolo manicure in in nobilitato bianco frassinato caratterizzato dal top ad alto spessore dalla forma squadrata e con fori passacavi. Il mobiletto laterale è provvisto di un cassetto piccolo e due cassettoni, collegato al piano di lavoro con colonnine cromate.

DIMENSIONI (mm)

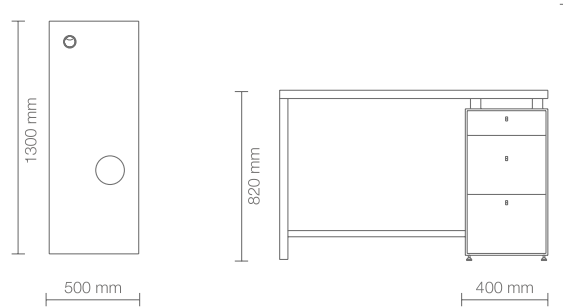

- ARMB-MB/MT015
- ARMB-MB/MT016 - con aspiratore 30W
- ARMB-MB/MT019 - con aspiratore 60W



FINITURE

Struttura Nobilitato bianco



Aspiratore
30W



Aspiratore
60W

Logic Double Tavolo Manicure

Ampio tavolo manicure in in nobilitato bianco frassinato caratterizzato dal top ad alto spessore dalla forma squadrata e con fori passacavi. I due mobiletti laterali sono provvisti di un cassetto piccolo e due cassettoni e sono collegati al piano di lavoro con colonnine cromate.

DIMENSIONI (mm)

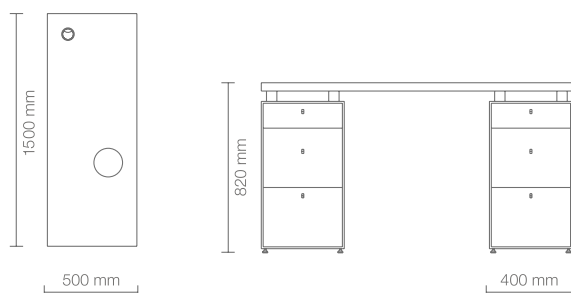

- ARMB-MB/MT017
- ARMB-MB/MT018 - con aspiratore 30W
- ARMB-MB/MT020 - con aspiratore 60W



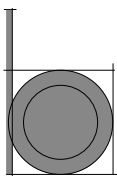

- ARMB-MB/MT130
- ARMB-MB/MT131 - con aspiratore 30W
- ARMB-MB/MT132 - con aspiratore 60W



FINITURE

Struttura Nobilitato bianco



Aspiratore
30W



Aspiratore
60W

Glitter Tavolo Manicure

Il tavolo manicure Glitter presenta una linea moderna e pulita, dal design minimalista. Lo stile essenziale della struttura in nobilitato bianco e del pannello laterale è completato da due eleganti e pratici ripiani in vetro per l'esposizione dei prodotti. Glitter è disponibile con e senza aspiratore.

DIMENSIONI (mm)

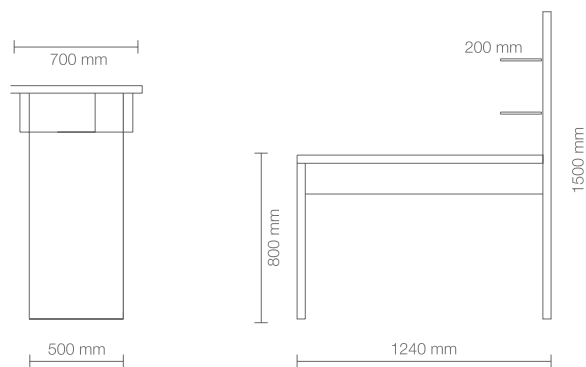

FINITURE

Struttura Nobilitato bianco



Aspiratore
60W

Nat Tavolo Manicure

Tavolo manicure Nat in nobilitato bianco opaco. Piano disponibile senza o con foro per aspiratore Helios 280. Mensola con spazio dedicato per lampada UV per unghie.

DIMENSIONI (mm)

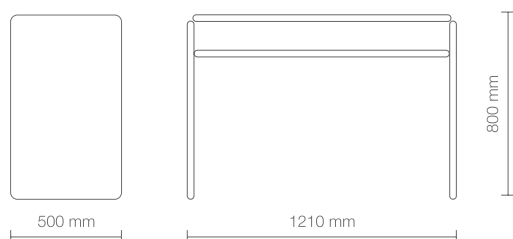

- ARCO-TNSFB
- ARCO-TNFB - con aspiratore





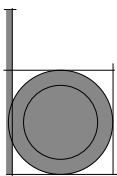

• ARWE-WK-M014

FINITURE

Bianco



Aspiratore
60W

Handy Tavolo Manicure

Elegante tavolino da manicure di legno compensato color bianco completo di piano tavolo e due eleganti e pratici ripiani in vetro per i prodotti. Dotato di aspiratore, sacchetto, cuscino appoggiamani e una doppia colonna con cassetti. Ruote incluse.

DIMENSIONI (mm)

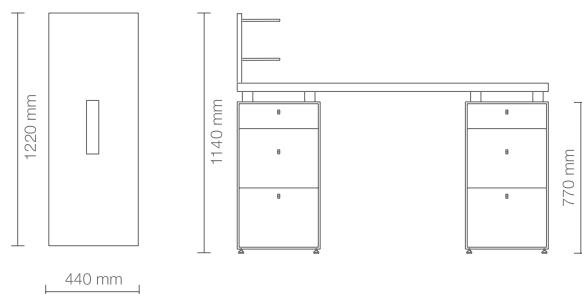

FINITURE

Bianco



Aspiratore
60W

Linear Tavolo Manicure

Elegante tavolino da manicure di legno compensato color bianco, con aspiratore, sacchetto e cuscino appoggiamani. Gamba di supporto cromata e colonna con due cassetti.

DIMENSIONI (mm)

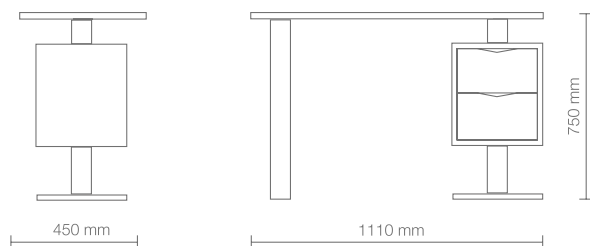

• ARWE-WK-M015

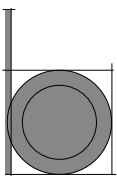

FINITURE

Bianco



Aspiratore
60W



Bose Tavolo Manicure

Tavolino da manicure minimale e moderno realizzato in legno color bianco completo di aspiratore, sacchetto e cuscino poggiamani. Si appoggia su di una gamba cromata e una colonna con 3 cassetti.

DIMENSIONI (mm)

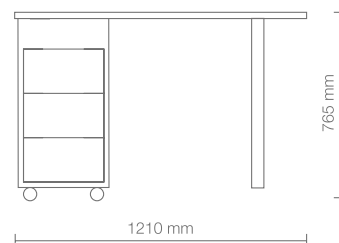
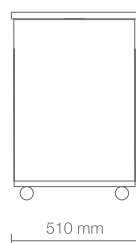

- ARWE-WK-M002

FINITURE

Bianco



Aspiratore
60W

Multiplex Tavolo Manicure

Tavolino da manicure realizzato in legno color bianco. Dotato di sacchetto e cuscino poggiamani. Fornito di due colonne con 4 cassetti ogniuna collegati al piano di lavoro con colonnine cromate. Ruote ed aspiratore incluse.

DIMENSIONI (mm)

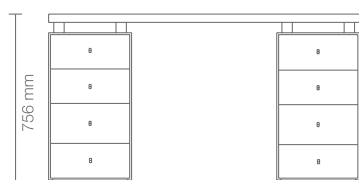
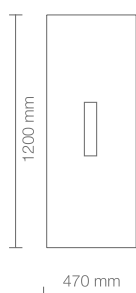

- ARWE-WK-M001

07



G f @ p y v

www.beautyprogress.net



CARRELLI

TORNA ALL'INDICE

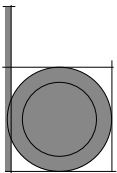

FINITURE

Struttura bianco opaco



Rovere bardolino



Larice bianco



bianco opaco



Creo Carrello

Creo è un ottimo complemento di lavoro dal carattere originale e raffinato, realizzato in nobilitato bianco opaco con ripiani disponibili in tre diverse finiture: larice bianco, rovere bardolino e bianco opaco. Pensato nei minimi dettagli, Creo è adattabile ad ogni esigenza. Il piano superiore durante la fase di montaggio può essere posizionato a filo struttura, soluzione ideale come piano d'appoggio per i macchinari.

- **ARCO-BPCCRB** - rovere



DIMENSIONI (mm)

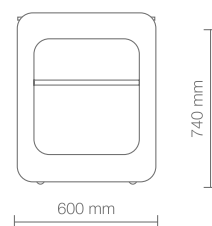

- **ARCO-BPCCLB** - larice
- **ARCO-BPCCBO** - bianco

FINITURE

Struttura bianco opaco



Rovere bardolino



Larice bianco



Wengé naturale



Swing Carrello

Swing è il carrello realizzato in Nobilitato bianco lucido, dotato di due comodi cassetti e un vano a giorno centrale. Finiture disponibili in larice bianco, rovere bardolino e wengé naturale.

DIMENSIONI (mm)

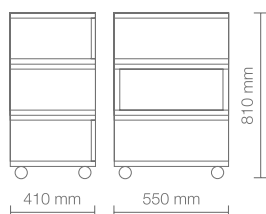

- **ARCO-BPCSWRB** - rovere



- **ARCO-BPCSWLB** - larice
- **ARCO-BPCSWWN** - wengé

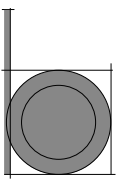

- **ARCO-BPCHLAS** - legno acero
- **ARCO-BPCHVAS** - vetro acero

- **ARCO-BPCHLW** - legno wengè
- **ARCO-BPCHVW** - vetro wengè



FINITURE

Acero sbiancato



Wengè



Hosi Legno & Hosi Vetro Carrello

Carrello a tre ripiani realizzato in legno multistrato di Betulla finlandese, resistente all'acqua e completamente smontabile. Lucidatura con finitura ecologica e ripiani in legno o vetro satinato. Disponibile in Acero sbiancato e Wengè.

DIMENSIONI (mm)

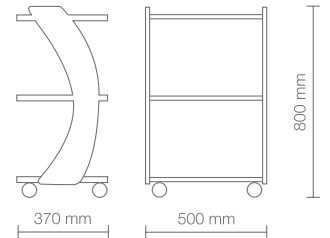

FINITURE

Struttura Cashmere



Stardust Carrello

Mobile carrello con base e mobile con cassettoni in melaminico finitura sabbia opaco (cashmere). Contenitore sotto mobile in plex fumè. Staffe metalliche di sostegno in finitura nero opaco.

DIMENSIONI (mm)

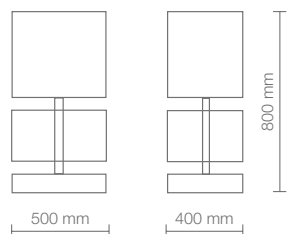

- **ARRNI. N83462**

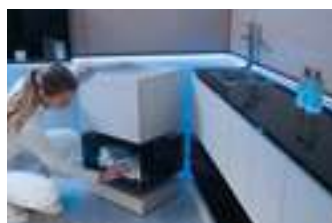

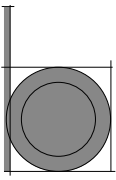

- ARCO-BPCOB

FINITURE

Laccato bianco opaco



Oboro Carrello

Oboro è un carrello realizzato in legno multistrato di betulla a tre ripiani, laccato bianco. Il vassoio superiore può essere girato e posizionato a filo struttura, soluzione ideale come piano d'appoggio per i macchinari.

DIMENSIONI (mm)

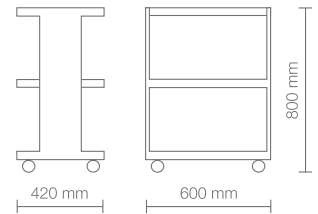

FINITURE

Struttura bianco opaco



Narciso Nails Cassettiera

Cassettiera estraibile realizzata in nobilitato bianco per tavolo manicure Narciso dotata di un cassetto su guide a rulli, un'anta e 4 ruote (2 con freno e 2 senza).



- ARRNI-N8303

Carrello Oboro



**Carrello Stardust
Mobile Horizon**

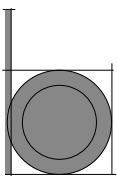

- **ARRNI-N8345**



FINITURE

Rovere sbiancato



Rovere chiaro



Noce



Acacia Carrello

Carrello completo di ruote e top vetro temprato serigrafato bianco coprente. Struttura in legno rovere o noce con angoli arrotondati. 2 vani porta oggetti.

DIMENSIONI (mm)

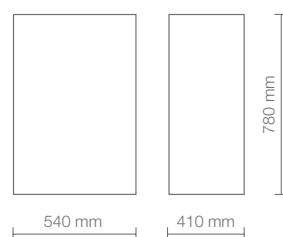

FINITURE

Rovere sbiancato



Rovere chiaro



Noce



Driade Carrello

Cassettiera su ruote con top vetro temprato serigrafato bianco coprente. Struttura in legno con angoli arrotondati, dotato di cassetto contenitivo e ampio vano portaoggetti.

DIMENSIONI (mm)

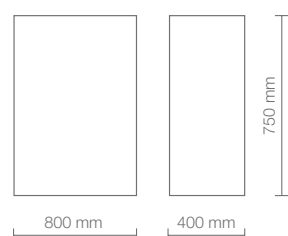

- **ARRNI-N81121**





Carrello Acacia
Lettino Ninfea
Mobile Kiwi
Sgabello Aloe



Carrello Driade
Lettino Ninfea
Mobile Kiwi
Sgabello Aloe

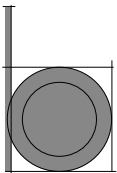

• **ARRNI-N8110**

FINITURE

Rovere sbiancato



Rovere chiaro



Noce



Edera Carrello

Cassettiera su ruote con top vetro temprato serigrafato bianco coprente. Struttura in legno rovere o noce con angoli arrotondati, 5 cassetti contenitivi.

DIMENSIONI (mm)

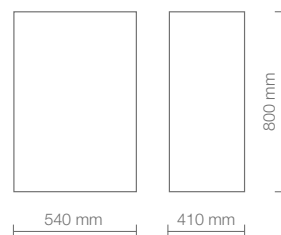

FINITURE

Rovere chiaro



Dione Carrello

Carrello in nobilitato bianco con fianchi curvati in finitura rovere. Top in nobilitato disponibile nelle essenze, ruote girevoli, 2 con freno e 2 libere, 1 vano riponi oggetti, 1 vano estraibile (200 mm) come zone lavoro e 1 cassetto su guide rulli.

DIMENSIONI (mm)

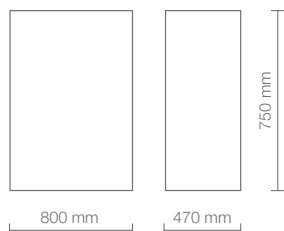

• **ARRNI-N8388**





Carrello Edera
Letto Ninfea



Carrello Dione
Tavolo Narciso
Poltrona Green Hug
Sgabello Aloe

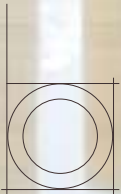

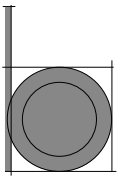

• ARCO-CNATRN

FINITURE

Struttura Rovere naturale



Nat Carrello

Carrello in nobilitato dalla finitura rovere naturale. Dotato di doppio piano di appoggio e maniglie laterali.

DIMENSIONI (mm)

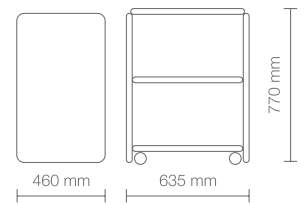

FINITURE

Struttura bianco opaco



Nat Nails Cassettiera

Cassettiera nail Nat con struttura in nobilitato bianco opaco. Cassettiera dotato di cassetto, vano porta flaconi e piano superiore porta-smalti.

DIMENSIONI (mm)

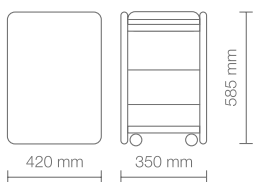

• ARCO-CNB



Letino Flow
Carrello Nat



Cassettiera e Tavolo Nat



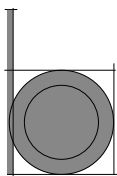

• **ARCO-CLIRB** - rovere



• **ARCO-CLILB** - larice

FINITURE

Struttura bianco opaco



Rovere bardolino



Larice bianco



Living Carrello

Carrello lineare e semplice, curato nei particolari realizzato in nobilitato bianco opaco con ripiani disponibili in due diverse finiture: larice bianco e rovere bardolino. Il piano superiore durante la fase di montaggio puo' essere posizionato a filo struttura, soluzione ideale come piano d'appoggio per i macchinari.

DIMENSIONI (mm)

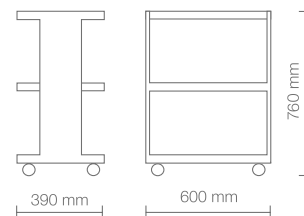

FINITURE

Struttura bianco opaco



Rovere bardolino



Larice bianco



Living Nails Cassettiera

Cassettiera Living realizzata in nobilitato bianco opaco con cassetti disponibili in due diverse finiture: rovere bardolino e larice bianco. È utilizzata come complemento dei tavoli Living e Living Led.

DIMENSIONI (mm)

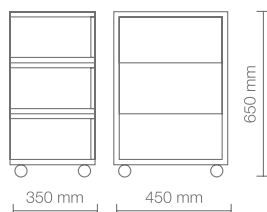

• **ARCO-CLRB** - rovere



• **ARCO-CLLB** - larice

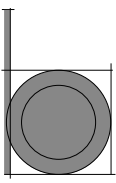

FINITURE

Bianco



Tux Carrello

Elegante carrello dalla struttura in legno laccato bianco. Dotato di 3 cassetti e uno spazio centrale per le apparecchiature con ripiano estraibile.

DIMENSIONI (mm)

- ARWE-1035A

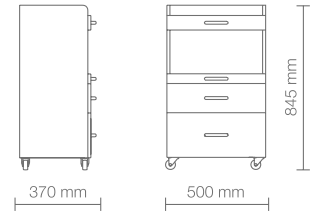

FINITURE

Bianco



Sol Carrello

Carrello bianco di legno compensato a 3 cassetti, uno dei quali è fornito di luce UV per la sterilizzazione degli strumenti. È dotato anche di uno spazio centrale con ripiano estraibile.

DIMENSIONI (mm)

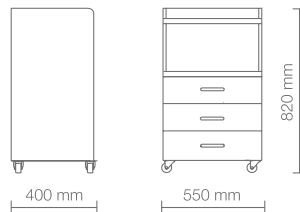

- ARWE-WK-T001

FINITURE

Bianco



- ARWE-1032

Hand Trolley Carrello

Elegante e moderno carrello di legno verniciato bianco. Dotato di 4 cassetti per conservare gli accessori nei centri di bellezza. Totale mobilità grazie alle 4 ruote.

DIMENSIONI (mm)

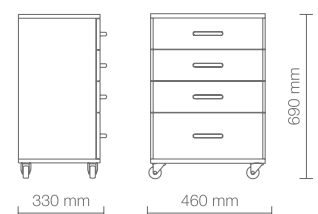

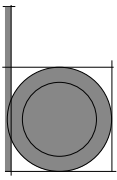

Hepl, Easy & Plus Trolley



• ARWE-1013

FINITURE

Bianco



Help Carrello

Carrello metallico bianco dal design minimalista. Dotato di 3 ampi ripiani in legno. Mobilità totale grazie alle sue 4 ruote e maniglia posteriore.

DIMENSIONI (mm)

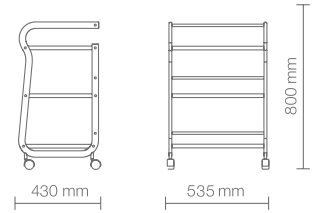

FINITURE

Struttura Nobilitato bianco



Easy Trolley Carrello

Carrello dalla struttura metallica bianca con un cassetto con chiave a 3 ripiani, disegnato per appoggiarvi delle apparecchiature. Mobilità totale grazie alle 4 ruote.

DIMENSIONI (mm)

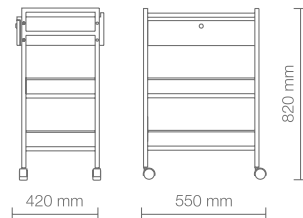

• ARWE-1019A

FINITURE

Bianco



Easy Plus Trolley Carrello

Carrello dalla struttura metallica bianca con 2 ripiani e 2 cassetti con chiave disegnato per appoggiarvi delle apparecchiature. Mobilità totale grazie alle sue 4 ruote.

DIMENSIONI (mm)

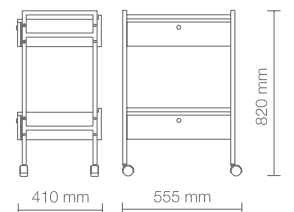

• ARWE-1019

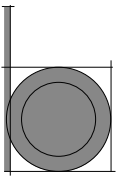

• ARWE-1040

FINITURE

Bianco



Facile Trolley Carrello

Carrello di metallo bianco dal design semplice e pratico. Dotato di 3 grandi ripiani di vetro traslucido su cui appoggiare le attrezzature. Mobilità totale grazie alle sue 4 ruote.

DIMENSIONI (mm)

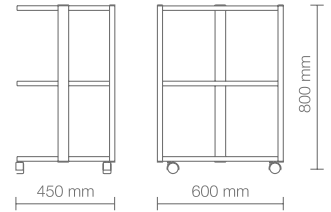

FINITURE

Bianco



Facile Plus Trolley Carrello

Carrello metallico bianco dotato di un cassetto con chiave e 2 ampi ripiani in vetro traslucido su cui riporre la strumentazione. Totale mobilità grazie alle sue 4 ruote.

DIMENSIONI (mm)

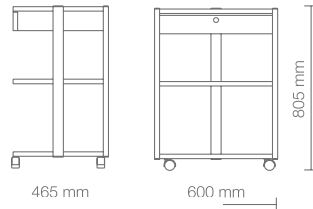

• ARWE-1040A

FINITURE

Bianco



MobilOne Carrello

Carrello dalla struttura metallica bianca dal design moderno e pratico. Dotato di 4 ripiani di vetro traslucido e borsa laterale. Totale mobilità grazie alle sue 4 ruote.

DIMENSIONI (mm)

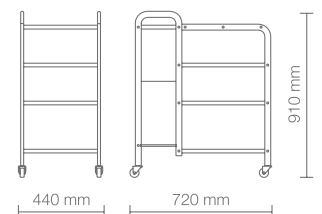

• ARWE-1031

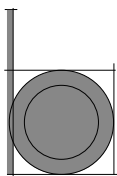

Part Trolley, Majal & Service

FINITURE

Bianco



Part Trolley Carrello

Carrello metallico bianco dotato di 3 ampi ripiani di plastica e un cassetto estraibile anch'esso di plastica. Mobilità totale grazie alle 4 ruote e la maniglia posteriore.

DIMENSIONI (mm)

- ARWE-1017

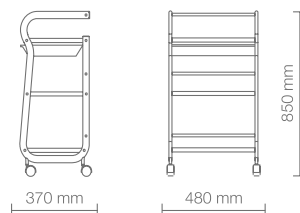

FINITURE

Bianco



Majal Carrello/Sgabello Manicure e Pedicure

Carrello con seduta imbottita e tavolino mani/pedicure laterale, regolabile e girevole con cusino e ciotole per le mani. Sgabello e poltroncina dotata di due cassetti, entrambi con ruote. Poggiatesta regolabile.

DIMENSIONI (mm)

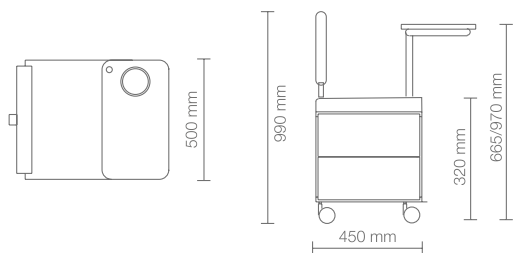

- ARWE-WK-P002

FINITURE

Bianco



Nero



Service Carrello/Sgabello Manicure e Pedicure

Carrello con seduta imbottita e tavolino mani/pedicure. Dotato di 3 cassetti e supporto laterale appoggiamani girevole. Disponibile in bianco e nero.

DIMENSIONI (mm)

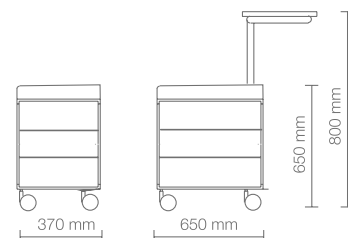

- ARWE-WK-M005



MENSOLE



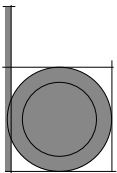

FINITURE

Struttura bianco opaco



Rovere bardolino



Larice bianco



Wengé naturale



- **ARCO-MSTRB** - rovere



- **ARCO-MSTW** - wengè



- **ARCO-MSTLB** - larice

Stratos Mensola

Mensola lineare da parete, semplice ed essenziale, con struttura bianco opaco e inserto disponibile in 3 diverse finiture: rovere bardolino, larice bianco e wengé naturale.

DIMENSIONI (mm)



FINITURE

Struttura bianco opaco



Rovere bardolino



Larice bianco



Wengé naturale



Slim Mensola

Mensola da parete posizionabile in verticale o orizzontale, con struttura bianco opaco e pannello a parete in tre diverse finiture: rovere bardolino, larice bianco e wengé naturale. Affiancando più moduli si possono arredare pareti creando un gioco di movimenti.

DIMENSIONI (mm)

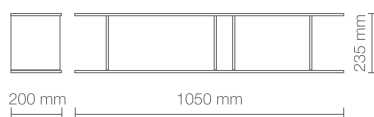

- **ARCO-MSRB** - rovere



- **ARCO-MSWN** - wengè



- **ARCO-MSLB** - larice

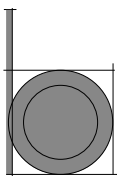

• ARCO-BPMEAS - acero



• ARCO-BPMEW - wengè

FINITURE

Acero sbiancato



Wengé



Elos Mensola

Mensola a tre piani realizzata in legno multistrato di Betulla finlandese, resistente all'acqua e completamente smontabile. Trattamento di lucidatura con finitura ecologica. Possibilità di aumentare l'estensione della mensola unendo più elementi. Disponibile in wengè e acero sbiancato.

DIMENSIONI (mm)

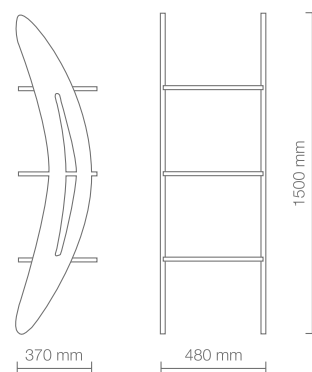

FINITURE

Nobilitato bianco



Rovere naturale



Nat Mensola

Mensola Nat a parete in nobilitato bianco opaco. Bordatura in rovere naturale.

DIMENSIONI (mm)



• ARCO-MNBRN



Mensola Slim



Mensola Nat

09

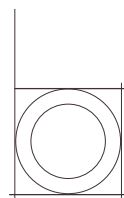
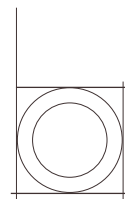
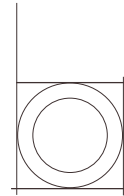
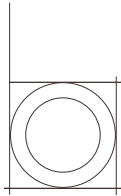
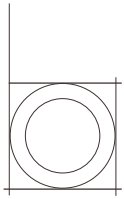

SCABELLI

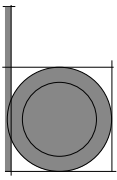

Ergo Stool, Fast & Plus

FINITURE

Bianco



Grigio scuro



• ARWE-1028

Ergo Stool Sgabello

Sgabello dal design innovativo per pedicure. Rotazione dello schienale a 360° funziona come appoggio lombare e anche come appoggiagomiti. Stativo e schienale color nero.

DIMENSIONI (mm)

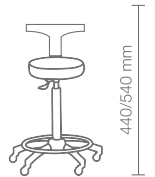

FINITURE

Bianco



Grigio scuro



Nero



Fast Sgabello

Sgabello dal design pratico. Sedile piano e circolare regolabile in altezza con pistone a gas. Rivestimento in PU di alta qualità e stativo cromato.

DIMENSIONI (mm)



• ARWE-1023A

FINITURE

Bianco



Nero



• ARWE-1023AB2

Fast Plus Sgabello

Sgabello con schienale ergonomico. Sedile piano e rotondo con altezza regolabile con un pistone a gas. Rivestimento in PU di alta qualità e stativo cromato.

DIMENSIONI (mm)



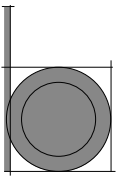

Comfort, Dynamic & Noble Stool



• ARWE-1025B

FINITURE

Bianco



Grigio scuro



Comfort Sgabello

Sgabello dallo schienale ergonomico con sedile piano e circolare per il massimo comfort. Dotato di 3 leve a gas che regolano l'altezza, l'inclinazione dello schienale e del sedile. Rivestimento in PU bianco di alta qualità e stativo cromato.

DIMENSIONI (mm)



FINITURE

Bianco



Dynamic Sgabello

Sgabello dal design ergonomico con schienale ovale e sedile a forma di sella. Dotato di 3 leve a gas che regolano l'altezza, l'inclinazione dello schienale e del sedile. Rivestimento in PU bianco di alta qualità e stativo cromato con 5 ruote.

DIMENSIONI (mm)

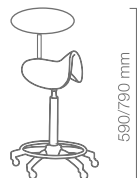

• ARWE-1025

FINITURE

Bianco



Nero



Grigio scuro



Noble Stool Sgabello

Sgabello con schienale avvolgente e sedile a forma di sella per il massimo comfort. Dotato di 3 leve a gas che regolano l'altezza, l'inclinazione dello schienale e del sedile. Rivestimento in PU bianco di alta qualità e base cromata.

DIMENSIONI (mm)

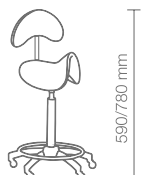

• ARWE-1025A

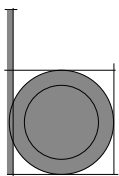

Practi Stool & Plus, Easy

FINITURE

Bianco



• ARWE-1021A

Practi Stool Sgabello

Pratico sgabello dal design ergonomico. Sedile a forma di mezza sfera, regolabile in altezza con un pistone a gas. Rivestimento in PU di alta qualità e stativo cromato con 5 ruote.

DIMENSIONI (mm)



FINITURE

Bianco



Practi Stool Plus Sgabello

Sgabello con schienale dal disegno ergonomico ed elegante. Sedile a forma di mezza sfera e regolabile in altezza con un pistone a gas. Stativo con 5 ruote.

DIMENSIONI (mm)

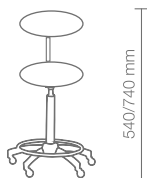

• ARWE-1021AB2

FINITURE

Bianco



• ARCO-BPSERB

Easy Sgabello

Sgabello con seduta realizzata in poliuretano pellato di colore bianco e basamento con ruote in acciaio cromato. L'altezza è variabile attraverso un sistema di regolazione a gas.

DIMENSIONI (mm)



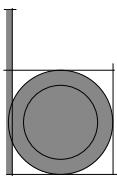

FINITURE

Bianco



Grigio scuro



Nero



Organic Sgabello

Sgabello dal design ergonomico ed elegante e sedile a forma di sella. Regolabile in altezza con un pistone a gas. Rivestimento in PU di alta qualità e stativo cromato a 5 ruote.

DIMENSIONI (mm)



• ARWE-1022A

FINITURE

Bianco



Nero



Organic Plus Sgabello

Sgabello dal design ergonomico con sedile a forma di sella e schienale ovale dal massimo comfort. Altezza regolabile con un pistone a gas. Rivestimento in PU di alta qualità e stativo cromato con 5 ruote.

DIMENSIONI (mm)

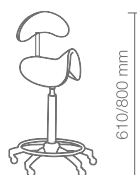

• ARWE-1022AB2



• ARCO-SBB

FINITURE

Bianco



Brio Sgabello

Sgabello con seduta realizzata in poliuretano bianco e basamento con ruote in acciaio cromato. Altezza variabile con regolazione a gas.

DIMENSIONI (mm)



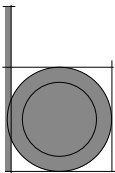

Montana, Arizona & Texas

FINITURE

skai colors



• ARMB-MB/S111

• ARMB-MB/S112 - base podologica

Montana Sgabello

Sgabello con sedile piano e circolare e schienale ergonomico in multistrato imbottito con gommapiuma ad alto spessore, rivestito in Skai. Altezza variabile con regolazione a gas e stativo cromato.

DIMENSIONI (mm)

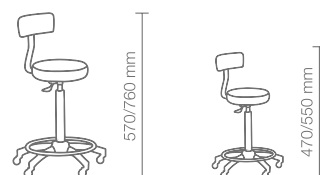

FINITURE

skai colors



Arizona Sgabello

Sgabello con sedile e schienale ergonomico in multistrato imbottito con gommapiuma ad alto spessore, rivestito in Skai. Altezza variabile con regolazione a gas e stativo cromato.

DIMENSIONI (mm)

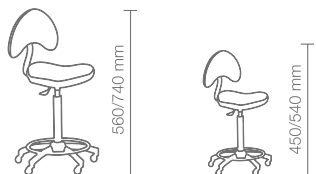

• ARMB-MB/S102 - base podologica

• ARMB-MB/S101



• ARMB-MB/S121

• ARMB-MB/S122 - base podologica

FINITURE

skai colors



Texas Sgabello

Sgabello con sedile piano e circolare in multistrato imbottito con gommapiuma ad alto spessore, rivestito in Skai. Altezza variabile con regolazione a gas e stativo cromato.

DIMENSIONI (mm)

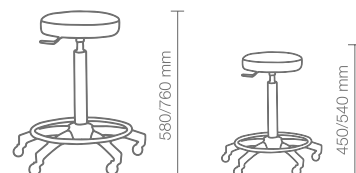

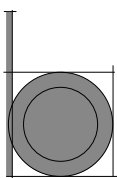

• ARMB-MB/S045

FINITURE

skai colors



Divine Sgabello Alto Reception

Sgabello da reception monoscocca in multistrato imbottito con gommapiuma, rivestito in Skai. Design estremamente moderno e stativo cromato senza ruote.

DIMENSIONI (mm)



FINITURE

skai colors



Rodeo Sgabello

Sgabello con seduta ergonomica dall'elevato comfort in multistrato imbottito con gommapiuma ad alto spessore, rivestito in Skai e stativo cromato.

DIMENSIONI (mm)



• ARMB-MB/S132 - base podologica



• ARMB-MB/S131



• ARMB-MB/S161



• ARMB-MB/S162 - base podologica

FINITURE

skai colors



Divine Sgabello

Sgabello monoscocca in multistrato imbottito con gommapiuma, rivestito in Skai. Design estremamente moderno e stativo cromato.

DIMENSIONI (mm)



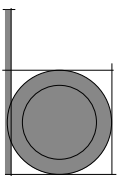

FINITURE

skai colors



- ARCO-BPSF

Flex Sgabello Oscillante

Flex è uno sgabello oscillante con sedile schiumato rivestito in skai disponibile in 14 colori. È dotato di doppio pulsante per la regolazione in altezza. La base è in gomma anti-stridio.

DIMENSIONI (mm)



FINITURE

Rovere sbiancato



Rovere chiaro



Noce



Aloe Sgabello

Sgabello con sedile rivestito in PVC. Schienale in legno con angoli arrotondati. Base in alluminio. Altezza regolabile con pompa-gas. Aloe con ruote speedy, Aloe podò ruote standard nere.

DIMENSIONI (mm)

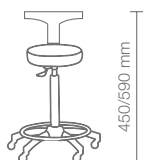

- ARRNI-N8533P - base podologica



- ARRNI-N8533

FINITURE

Bianco



Sunshine Sgabello

Sgabello su ruote con seduta rivestita in Soft PVC. Base in alluminio. Altezza regolabile con pompa gas. Ruote speedy. Disponibile con schienale in lamiera verniciata, colore warm grey 3U.

DIMENSIONI (mm)

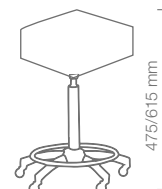

- ARRNI-N9018



- ARRNI-N9018E



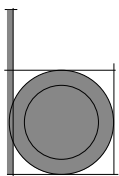

FINITURE

skai colors

Hex Divanetto Attesa

Una seduta d'attesa unica, progettata intelligentemente, disponibile con o senza schienale, Hex è sia un ottima attesa salva-spazio ed è perfetto per dare l'opportunità di avere più posti a sedere supplementari nella sala d'attesa. La seduta esagonale può essere collocata in diverse posizioni, creando un divertente ambiente aperto.

DIMENSIONI (mm)

COLOURS A ○ B ●

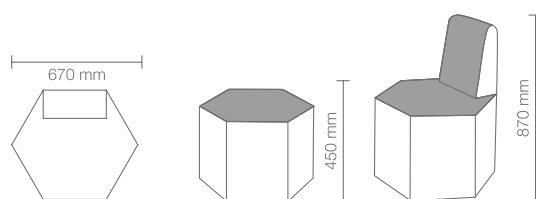

- ARMB-RC111 - con poggiaschiena
- ARMB-RC110

FINITURE

skai colors

Trasformer Divanetto Attesa

Le attese Trasformer hanno una struttura in legno multistrato, imbottiti e personalizzabili con i vari Skai® Colours. Transformer è disponibile in versione senza schienale oppure con schienale fissabile sul lato stretto o ampio della seduta.

DIMENSIONI (mm)

COLOURS A ○ B ●

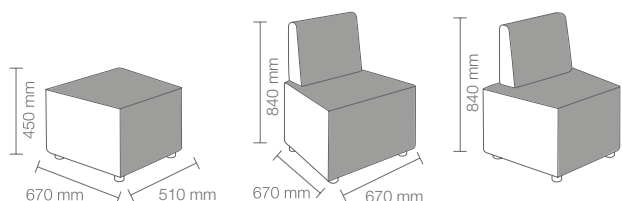

- ARMB-RC/052 - con poggiaschiena



- ARMB-RC/051 - con poggiaschiena



- ARMB-RC/050

Divanetto Trasformer
Colori A Vintage White G3
Vintage Brown F5

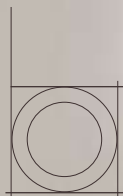
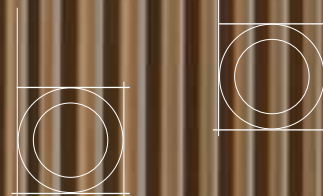

Divanetto Lounge
Colori A Vintage White G3
B VintageTan G2

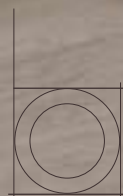

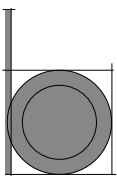

FINITURE

skai colors



• ARMB-RC/121

Elle Divanetto Attesa

Componibile e versatile, dal design essenziale e squadrato, con seduta e schienale imbottiti e confortevoli, l'attesa Elle è la soluzione perfetta per la tua zona attesa. Personalizzabili con i vari Skai® Colours.

DIMENSIONI (mm)

COLOURS A ○ B ●

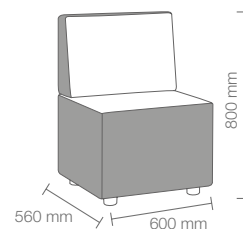

• ARMB-RC/081

FINITURE

skai colors

Lounge Divanetto Attesa

Il divano modulare Lounge è disponibile in tre versioni differenti: il posto singolo, il due posti e il divano tre posti che possono essere combinati assieme per dare vita a differenti versioni. Il design moderno è caratterizzato da curve sinuose ed offre uno stile unico allo spazio reception di ogni salone.



• ARMB-RC/082

DIMENSIONI (mm)

COLOURS A ○ B ●

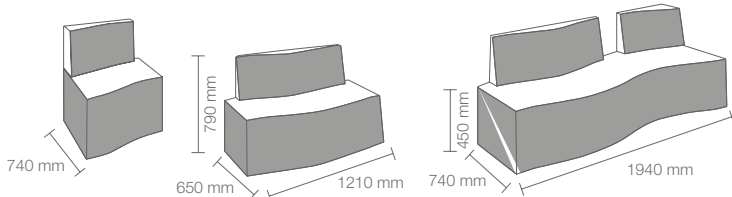

• ARMB-RC/083

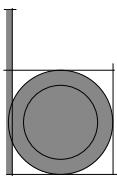

FINITURE

skai colors

B-Side Divanetto Attesa

B-Side è l'attesa a due posti dal design estremamente moderno. La seduta ha una forma ellittica dallo spessore importante e poggia su quattro piedi di alluminio. Il divano è disponibile in due versioni: nella versione a C più tradizionale e nella versione a S pensata per posizionare il divano centralmente.



• ARMB-SH/993 - C



• ARMB-SH/994 - S

DIMENSIONI (mm)

COLOURS A ○ B ●

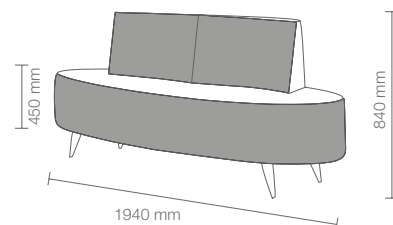

FINITURE

skai colors

Opale Divanetto Attesa

La linea Opale comprende un divano a due posti ed una poltrona dalle linee morbide e dal design moderno. Per queste attese è possibile rendere unica la propria personalizzazione utilizzando tutti gli skai® colors. Il tutto in due varianti: mono colore o bicolore nell'abbinamento della seduta con lo schienale.

DIMENSIONI (mm)

COLOURS A ○ B ●

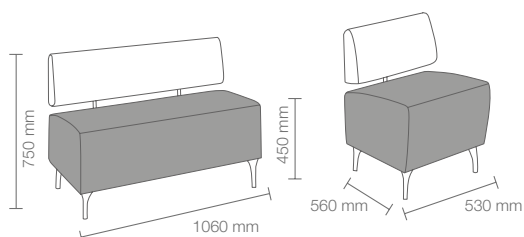

• ARMB-SH/954



• ARMB-SH/955

Divanetto B-Side
Colore Honey L1



Divanetto Opale
Colori A Vintage Grey K1
B Vintage Ice K8



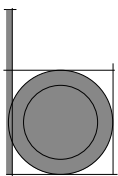

- ARMB-MB/R25

FINITURE

skai colors

Rumba Divanetto Attesa

Spazio alla fantasia con Rumba! Sbizzarrisciti con questo pouf originale e divertente per donare al tuo salone quel pizzico di creatività in più. Gioca con i colori e scoprine tutti i possibili utilizzi e collocazioni. Rumba è disponibile in una vasta scelta di Skai Colours, mono o bicolore.

DIMENSIONI (mm)

COLOURS A ○ B ●

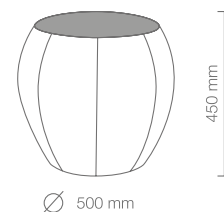

FINITURE

skai colors

Miami Divanetto Attesa

Pouff squadrati in legno ricoperti in gommapiuma, disponibili in tantissimi colori di Skai.

DIMENSIONI (mm)

COLOURS A ○ B ●

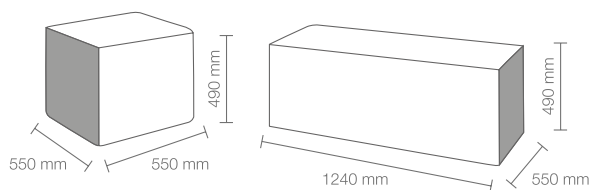

- ARMB-MB/R21



- ARMB-MB/R20

Attesa Rumba



Attesa Miami



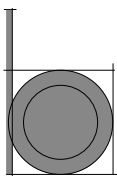

FINITURE

Struttura Rovere naturale



Nat Panca Attesa

Panca Nat realizzata in nobilitato con finitura rovere naturale. Bordo a terra in lamina di acciaio spazzolato.

DIMENSIONI (mm)



- ARCO-PNRN

FINITURE

skai colors

Nat Sofà

Coppia di cuscini di seduta per panca Nat Sofa. Disponibili in 12 colori skai.

DIMENSIONI (mm)

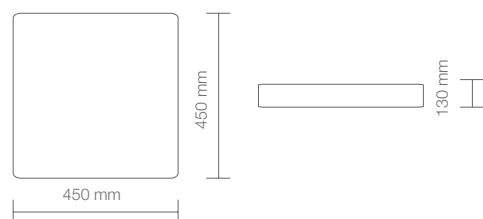



**Divanetto Nat Sofà
Reception e Mensole Nat
Sgabello Flex**



**Divanetto Nat Sofà
Carrello Creo**

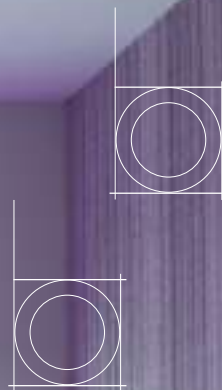

TORNA ALL'INDICE

ACCESSORI E COMPLEMENTI

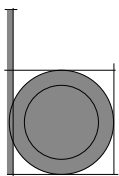

Sunset, Dan & Tris Bubbles

Sunset Cielo

Cielo con sistema riscaldante, tramite pannello radiante completo di illuminazione RGB per cromoterapia a 220V - 50Hz. Aggancio con cavi a soffitto.

DIMENSIONI (mm)

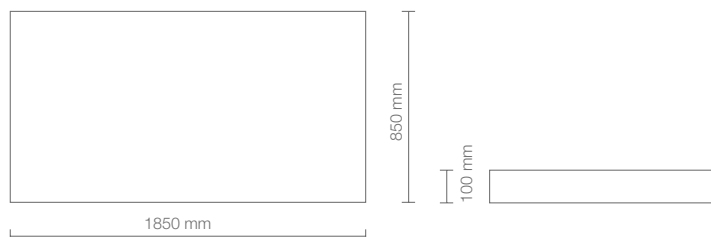

- **ARRNI-N9014**

FINITURE

Acero sbiancato



Wengé



- **ARCO-BPSDAS** - acero
- **ARCO-BPSDW** - wengé

Dan Scaletta

Scaletta a 2 scalini realizzata in legno multistrato di Betulla finlandese resistente all'acqua. Trattamento di lucidatura ecologica.

DIMENSIONI (mm)

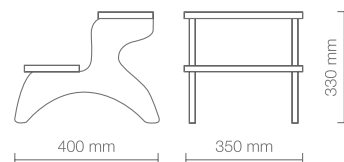

FINITURE

Bianco opaco



Tris Bubbles Specchiere

Set di tre specchi rotondi con telaio in alluminio verniciato bianco. L'illuminazione a LED ad alta potenza e' celata dallo specchio diffondendo luce naturale.

DIMENSIONI (mm)



- **ARCO-BPSTBB**

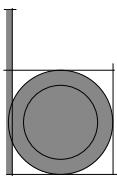

- ARCO-LTL

FINITURE

Alluminio



Living Lampada Nails

Lampada nails da appoggio pieghevole con illuminazione Led a basso consumo, struttura bianca.

FINITURE

Alluminio



Led Lamp Lampada Nails

Lampada nails Led con basamento regolabile e struttura in alluminio satinato.



- ACCN-WE/WK-M007-LED



- ARCO-BPPB

FINITURE

Bianco



Brio Poggiamani

Cuscino poggiamani realizzato in Skai bianco.

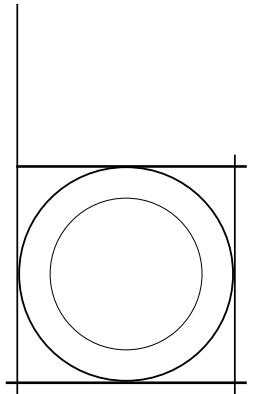
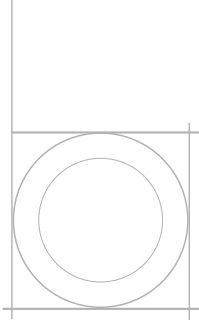
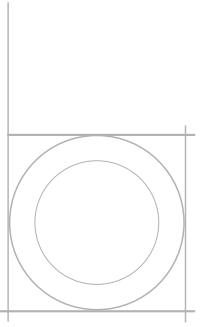
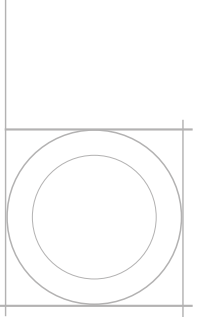
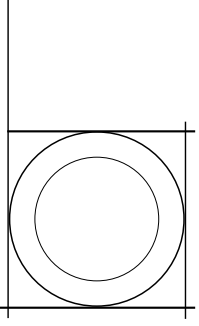
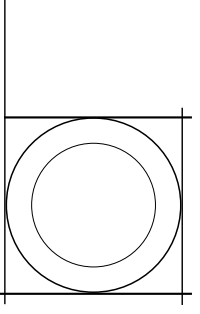

CARTELLA

colori

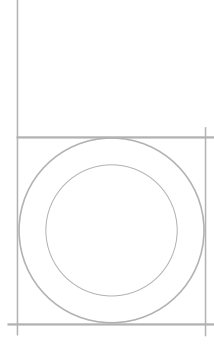
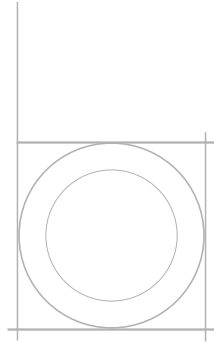
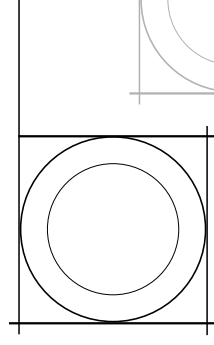
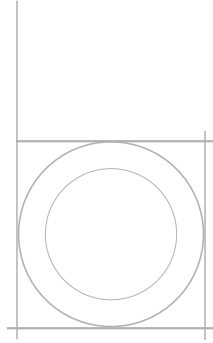
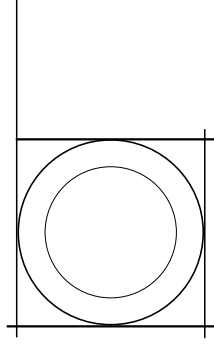
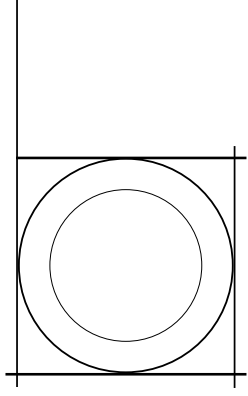

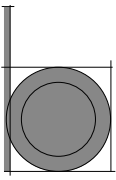

Skai Colors

Per tutti i codici ARMB aventi l'icona 



CHAMPAGNE 10



BLACK COFFEE 59



HOT CHOCOLATE 60



MILK 61



TEA 62



CAPPUCCINO 63



ESPRESSO 64



LIGHT GREY G5



DARK GREY G6



VINTAGE BROWN F5



VINTAGE BLACK G1



VINTAGE TAN G2



OLIVE G8



ROYAL BLUE G9



MARINE L2



VINTAGE ICE K8



BLACK ALLIGATOR 49



GREY ALLIGATOR 50



VINTAGE WHITE G3

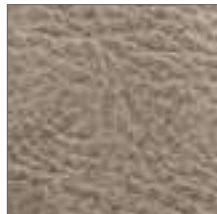

VINTAGE ASH G4



VINTAGE CHOCOLATE H9



VINTAGE GREY K1



VINTAGE BLUE K2



VINTAGE WINE K7



PEBBLE BLACK N1



SLATE GREY N2



PEACOCK BLUE N3



MULBERRY N4

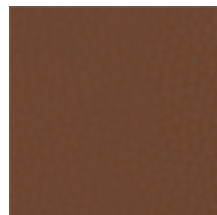

COGNAC N5



SAGE GREEN N6



BEIGE PEARL P4



COGNAC PEARL P5



GREEN PEARL P6



YELLOW PEARL P7



RED PEARL P8



PINK PEARL P9



BLACK PEARL P1

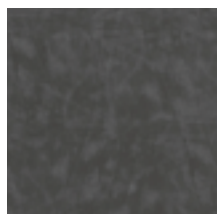

GREY PEARL P2



BROWN PEARL P3



CHOCOLATE MILK K3



STRAWBERRY MILK K4



GOLD K6

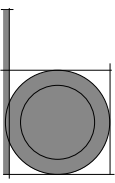

Finiture

Per tutti i codici **ARMB**



VINTAGE 01



BLACK ASH 02



CEMENT GREY 03



MOKA 04



OAK 05



WHITE ASH 06

Skai Colors

Per tutti i codici **ARCO** aventi l'icona 



VIS 10



VIS 12



VIS 14



VIS 16



VIS 18



VIS 20



VIS 30



VIS 32



VIS 34



VIS 40



VIS 42



VIS 44

Finiture

Per tutti i codici **ARCO**



ACERO SBIANCATO



LARICE BIANCO



ROVERE BARDOLINO



WENGÈ NATURALE

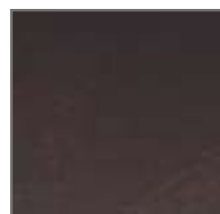

WENGÈ



OLMO MIELE



ROVERE FUMÈ



PAPER



ROVERE NATURALE

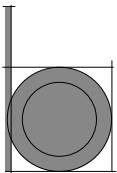

Finiture

Per tutti i codici **ARRNI**

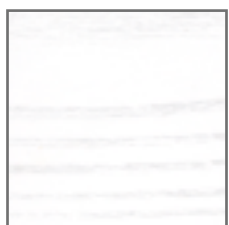

ROVERE SBIANCATO



ROVERE CHIARO



NOCE



WENGÈ



GRIGIO SATINATO

Skai Colors

Per tutti i codici **ARRNI** aventi l'icona



WHITE



BEIGE



LIGHT BEIGE

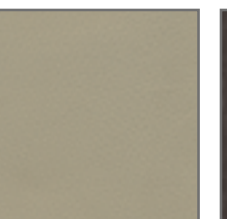

BRIGHT BEIGE



ESPRESSO



BLACK



PEARL



LIGHT GREY



FANGO VINTAGE



DARK GREEN



VISONE



DARK BROWN



CUOINETTO



ROSA



DESIGN

Ricerca

EMOZIONE

Stile

QUALITÀ

Tecnologia

ELEGANZA

Moda

FORMA

Tendenza

SOLIDITÀ

Innovazione

ARTE

Bellezza

CREATIVITÀ

Esperienza



Via Breda 5B



62012 Civitanova Marche (MC)



Tel. +39 0733/775025



info@beautyprogress.net



www.beautyprogress.net